

**PLANNING
DESIGNING
NETWORKING
DEVELOPING**



PLANNING DESIGNING NETWORKING DEVELOPING

Since the company was founded, ECO Schulte has consistently taken a holistic approach to the subject of “hardware on the door”. A product system was developed early on that made the world of doors more secure and more functional. We call that — to quote Aristotle — “the whole is greater than the sum of its parts”.

Today ECO Schulte offers much more than a product system. New areas of expertise have been added to a perfectly harmonised product range: the overarching design, the networking of products and the challenge of market- or order-based product development.



**THE ECO SCHULTE STORY:
WE ARE
FAMILY**

Much has already been philosophised about the charm of the family business in contrast to the corporate group. In our opinion, the main advantages are continuity, decisiveness and high flexibility. And a love of doing business.



A family business, an entrepreneurial family: siblings Tobias Schulte, Andrea Widmann, Heinz "Heiner" Schulte – and their father Ernst Schulte (from left).

A love of entrepreneurship is deeply rooted in the self-image of the Schulte family from Menden, Westphalia. The current generation of managing partners – **Andrea Widmann, Heinz and Tobias Schulte** – and their father, **Ernst Schulte**, can point to many successful industrialists in their immediate family as well as among more distant relatives. Ernst Schulte believes there is a kind of entrepreneurial gene that runs through the family: "We enjoy creating things, we enjoy building things!" The father has passed this down to the next generation and later wrote it in the family registry. And with the generational transition, the family has also broken new ground without leaving the path of growth.

The entrepreneurial gene lives on

The international expansion in sales has been advanced – as has international production. ECO Schulte operates production and sales branches in Menden, Luckenwalde in Brandenburg, Hermagor in Austria, Warsaw in Poland and Zhuhai, China – as well as in Randers, Denmark. Tobias Schulte, who is responsible for international business, views this as an inescapable strategy: "We have to have the right production and distribution mix to remain competitive as a medium-sized company."

Heinz Schulte favours the home market and sees Germany as another important success factor: "We have the world's most sophisticated building services market and the most demanding system of standards – if you can succeed here, you can succeed anywhere in the world with German engineering."

Andrea Widmann is responsible for business administration within the group of companies and juggles the numbers: "As a medium-sized company, we have to follow a growth course — but we have decided not to do this at any price. Quality takes precedence over quantity here as well."

Father Ernst Schulte thinks the company is on the right track and continues to support the team of managing partners with good advice. But he primarily devotes his time to the other passion of the entrepreneurial family: Europe, the European Youth Parliament and the idea behind European unification. This is no less than the democratic legacy of company founder Heinrich Schulte.

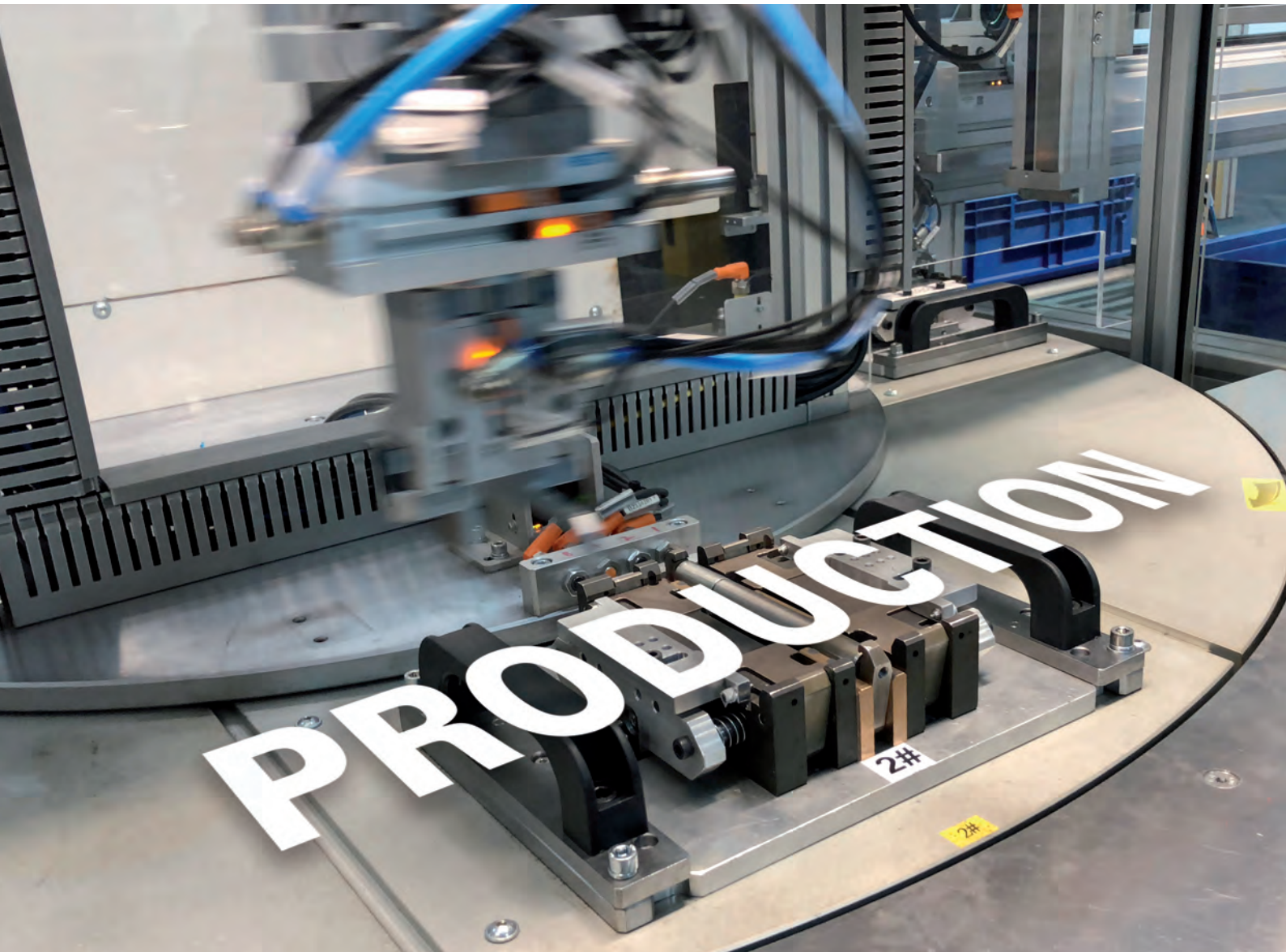

BECAUSE WE ALSO PRODUCE

If you enter a market as a system provider you must also have a command of the system. Arbitrarily purchased components are not our way of doing business. The concept of the company network includes fulfilling defined core competencies with our own production. ECO Schulte operates its own national and international production facilities.



BECAUSE SERVICE MEANS „GOING GLOBAL“

ECO Schulte from Menden, Westphalia, is active worldwide with planning support, development expertise and product solutions. German quality, design and functionality have been decisive factors in our international success. From airports, hospitals and hotels to office buildings: we have the right system for our customers.



REFERENCES

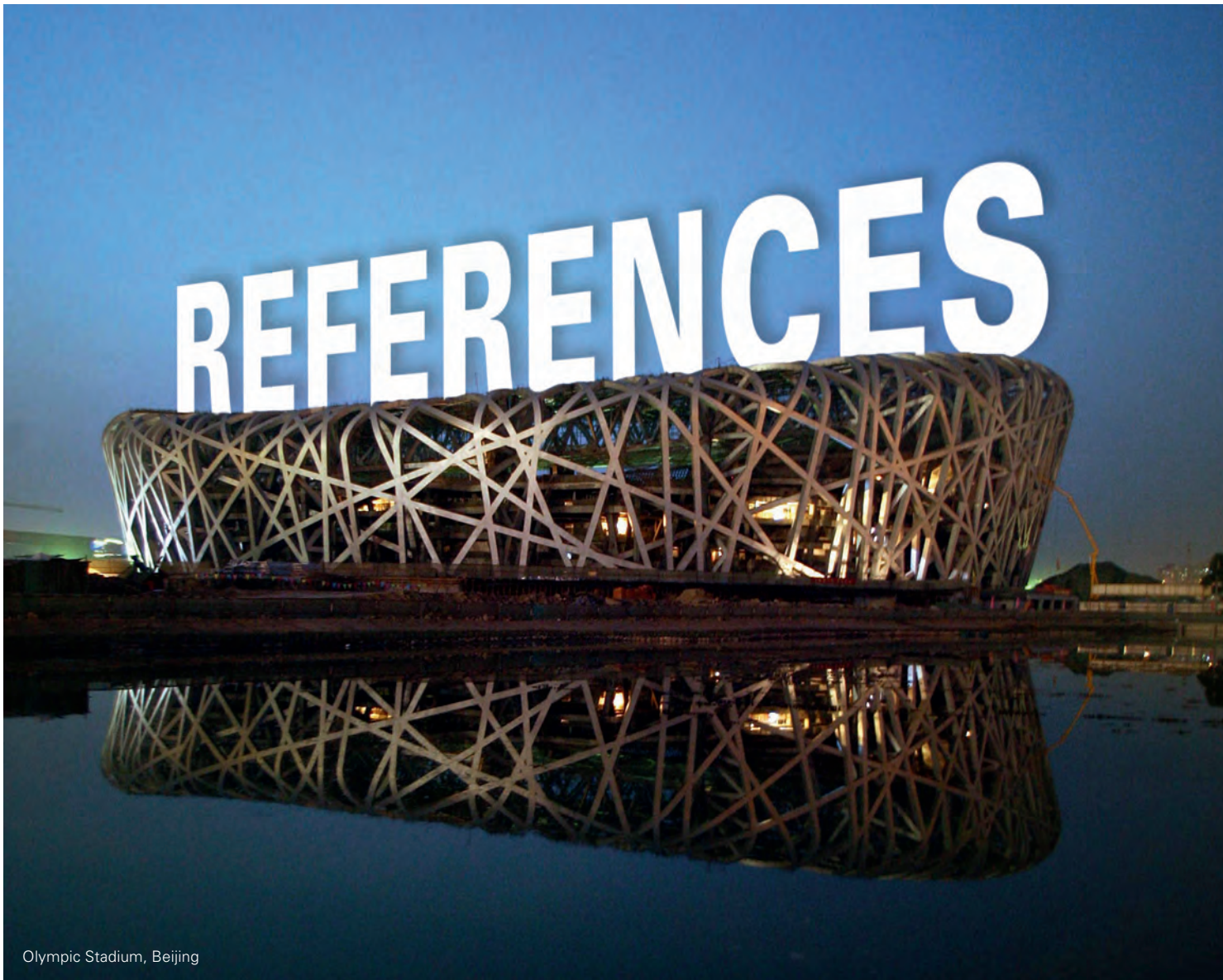

Olympic Stadium, Beijing



Trade Fair Centre, Stuttgart



Sports Hub, Singapore

PLANNING

Plan your project with fully coordinated,
**standards-compliant
product combinations**
– from the ECO Schulte
system product range.

DESIGNING

All design options:
From **highlight design**
for creative accents to
integrative design.
From timeless classics to bespoke design.

NETWORKING

Needs-based use of technology:

intelligent door management

from **stand-alone**
to **fully networked.**

DEVELOPING

Never say "can't":

**Development and
problem-solving expertise**

for the door industry and buildings when it comes to

**hardware that complies
with standards** on the door.



PLANNING

Everything from a single source: with our product range you can plan door systems without limitations and with confidence you are in compliance with standards. This is classic ECO Schulte: everything fits together, everything harmonises visually and in terms of surfaces. You have one contact person for complete functionality on the door.

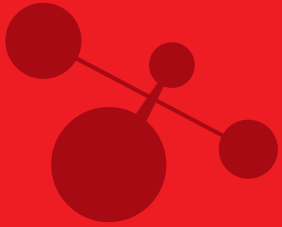

DESIGNING

Hardware on the door needs to be designed conceptually – we offer you the building blocks for that. Regardless of whether you want an integrative design with the goal of blending into architecture, or a highlight design that is meant to add accents. ECO Schulte and Randi always offer a solution.

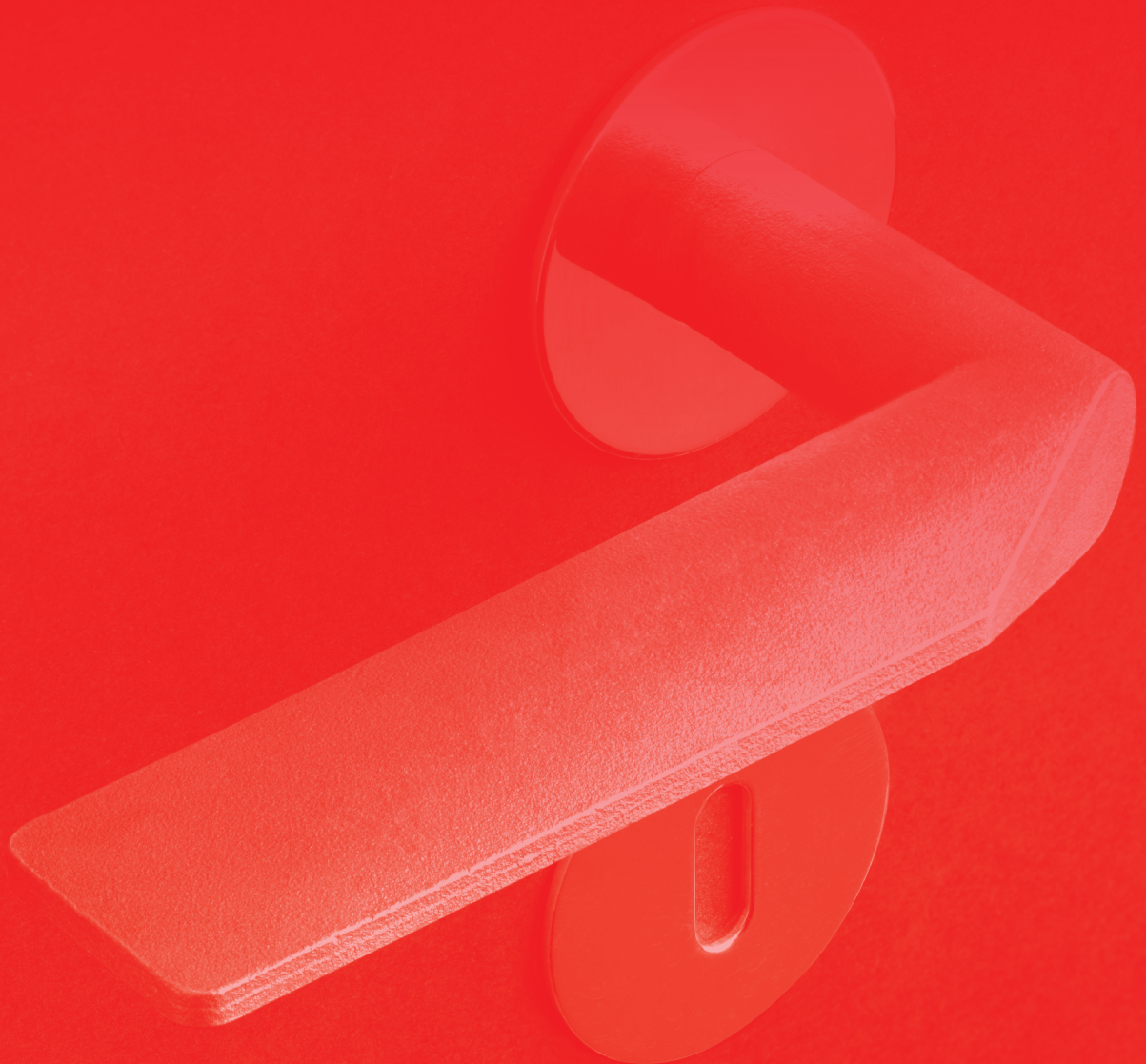



NETWORKING

The door is part of the building system. We offer everything you need to integrate the door into the building control system – from planning support to the product. From stand-alone solutions to digital integration into surveillance, security or building management systems.



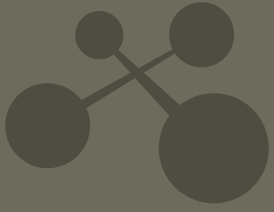

DEVELOPING

Decades of experience in developing and finding solutions for door systems distinguish this area of ECO Schulte expertise. Whether for the door industry or for buildings, whether in series production or bespoke production with potential for the future: our development specialists enjoy taking on challenges.





PLANNING

Abteilung:
Logistik Lager

Abteilungsleiter/in:
Herr Meyer

Verantwortlich für
Ordnung und
Sauberkeit:
Herr Schmidt

• SYSTEMECHANIK FÜR DIE TÜR





Product range with a system behind it

You are planning your door concept from our product range: everything from a single source. Hardware on the door is our core competence. We develop ourselves, manufacture ourselves – and serve you with the right product at the right time. Everything fits together, everything complies with standards. The whole is indeed greater than the sum of its parts.

PLANNING MEANS
PLANNING WITHIN A SYSTEM

DRAWING FROM A WIDE RANGE OF OPTIONS WITH STANDARDS

When we talk about planning, ECO Schulte is referring to the process of selecting door components with the guarantee of absolute compliance with standards. This involves configuring the hardware on the door and ensuring everything fits together according to the relevant standards.

The world of electronics opens up wonderful possibilities: convenience, security, networked systems – it's all possible. The technology of absolutely certain functionality under almost all conditions; but that's how mechanical elements work. Unbothered by empty batteries or power failure, impervious to environmental influences: **where human lives are at stake, mechanics are the means of choice.**

The fascinating thing about mechanical devices is also the reliability of their function – just think of grandmother's heirloom pendulum clock, reliably ticking the time to the minute for more than 80 years. Pure mechanics, highly sophisticated, artfully designed and masterfully manufactured. Now transfer that to the door: even after a decade of waiting for the perfect moment, mechanics are able to access a program that saves lives – as a result, the door closer can secure the smoke compartment.

4x Hinge
ECO Horizon OBX 18
EN 1935

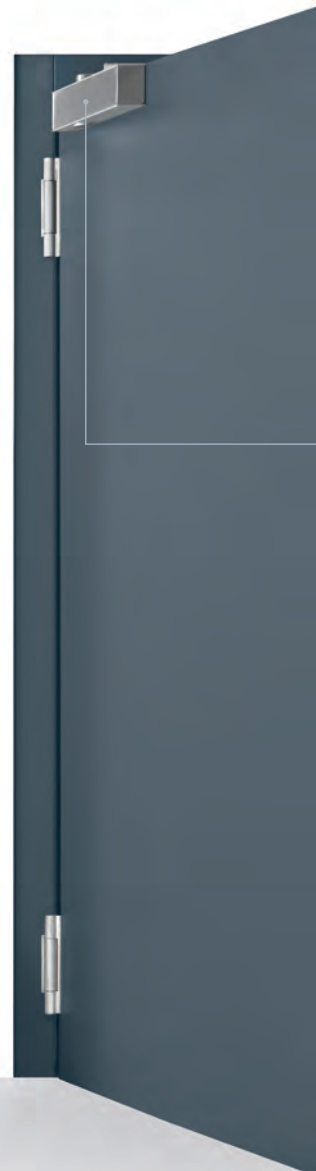



EN 1125

EN 1158

EN 1154

EN 1125

EN 1906

EN 12209

EN 1935



1x Closing sequence selector
SR-EFR-2
EN 1158

2x Door closer
ECO Newton TS-61
EN 1154

1x Panic lock keep
GBS 94
EN 12209

1x Touch bar
ECO Guardian EPN 2000 II
EN 1125

1x Push bar
ECO Guardian EPN 900 IV
EN 1125

1x Panic mortise lock
GBS 93
EN 12209

1x Fitting
ECO OKL Magis
EN 1906

SERVICE INITIATIVE

WE OFFER MORE THAN PRODUCTS

Our product range covers 95 percent of all practical applications in compliance with standards. But the product is only a part of what we can offer our customers in the door industry, in planning, in retail and in the trades.



Expertise to call on and call up: our service centre at our company headquarters is the consulting unit of the group of companies that supplies – or communicates – our know-how.



Friendly support: service and support are part of our corporate culture.

First, there is our advice and planning support. Whether online via the **door configuring tool**, on the **phone**, or in person at the **construction site**: ECO Schulte has established a network of **planning and implementation support** to accompany and support you in every project.

Our **experts from customer service, application technology and field service** know their product range and your challenges, provide help quickly and easily – and find a solution.

And this eagerness to provide service naturally continues far beyond the successfully completed project. Because we know that our value is especially judged by our **service after sales** – since our cooperation is designed to last. Long-standing customer relationships offer impressive evidence of this.

THE SECURITY PRINCIPLE

EVERYTHING FROM A SINGLE SOURCE

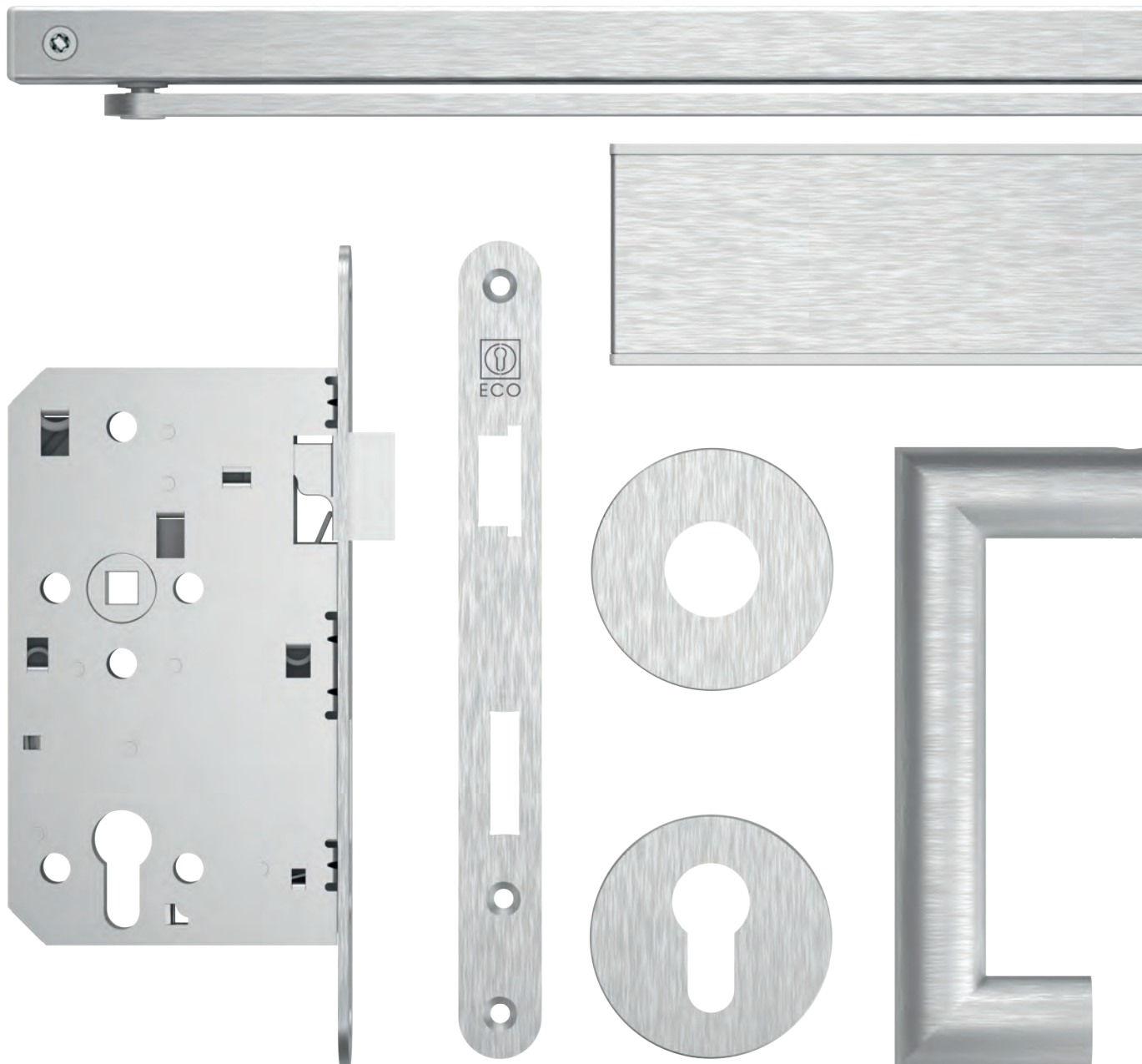



The door is a system made up of a wide variety of components that, in sum, must be perfectly matched with each other – and must function just as perfectly.

ECO Schulte is the system manufacturer for hardware on the door. The result is coordinated designs, coordinated materials and surfaces, consistent functionality – and **perfect compliance of all components with standards**. But a system is much more than just a product and much more than the sum of its components: **Service is a natural part of being a system provider.**

One face to the customer: for our system, we are the one competent partner for the planning, realization and warranty coverage of complex door systems. These are arguments that have persuaded our customers.

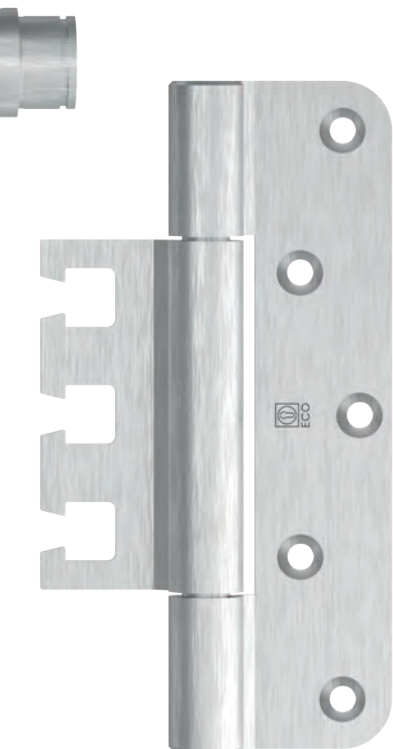

From a single source, with a consistent surface, and compatible with each other and with standards: the ECO Schulte product range.



ECO

PLANNING stands for planning with the ECO Schulte system range. You can find more information here on our website.

→ bit.ly/2F61bLo



DESIGNING



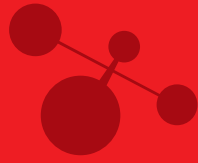

Design – precisely as you need it

There are many products in architecture that impress by not calling attention to themselves: our classic lever handles (right), for example. You can't go wrong with these – and users quickly learn to trust their look and feel. On the other hand, sometimes the aim is to add accents, such as with the handle. For this need we have Randi (left). Fresh architectural design from Scandinavia. Both from ECO Schulte.



INTEGRATIVE DESIGN

AESTHETICS

EX MACHINA

At ECO Schulte, „integrative design“ means a functional design that recedes in favour of the architecture and space. A design that does not push its way to the forefront – you could liken it to an aesthetic of blending in.

It always fits, doesn't polarize and conveys the impression of quality through its defined radii: the OKL Magis.





Integrated rather than added on: the door closer ECO ITS Multi Genius in the built-in version.

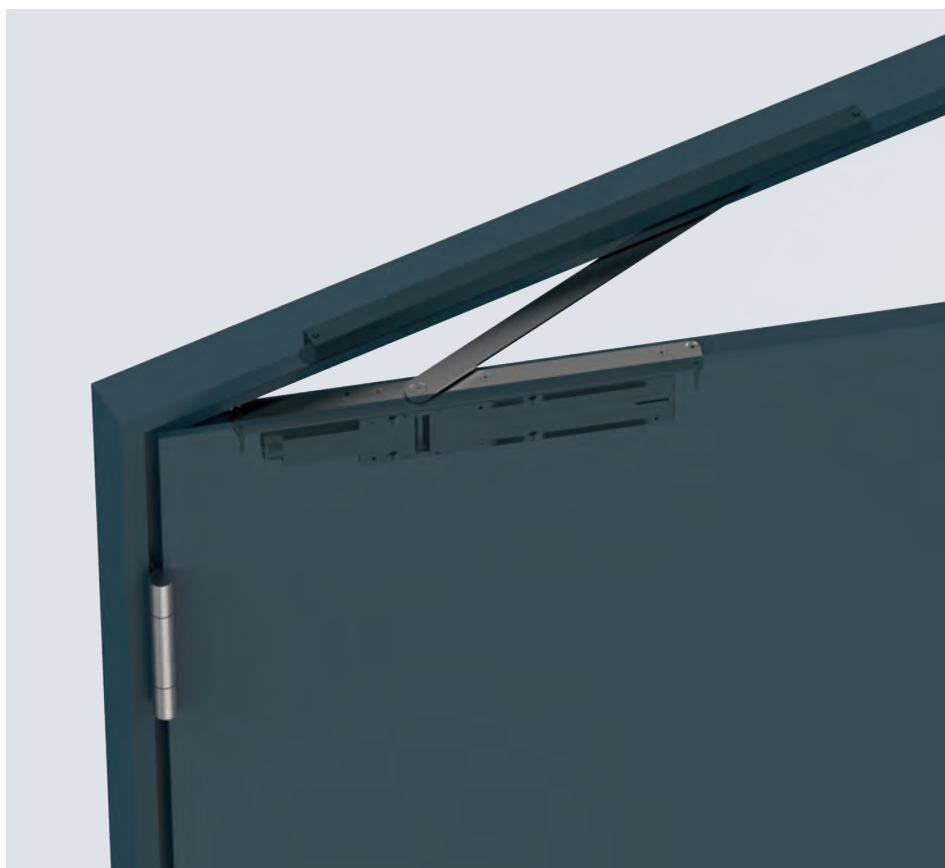

Many ECO Schulte products embody a classic design language that is subtle, simple and balanced. **They communicate order and security, trust, and a sure sense of style.**

For us, the most perfect form of integrative design is achieved when the product merges into the architecture in such a way that it is hardly noticeable. For example, the ITS Multi-Genius door closer, which is installed in the door leaf.

High-quality architecture and unobtrusive products harmonise perfectly with each other, as demonstrated by the premium OKL Magis fittings. Their smooth surface of satin stainless steel and the defined edges of the mere 9 mm flat rosettes appear discreetly elegant and precise on the door leaf. The love of perfection extends here to the last detail: the direction of the lines in the metallic surfaces is identical on all product parts.

The beauty of this restrained design is the result of paring down to the essentials and of its perfect function – intrinsic value that can be seen as well as felt.



HIGHLIGHT DESIGN

A SENSE FOR FRESH FORMS

We at ECO Schulte use the term “highlight design” for design products on the door that purposefully add accents to the architecture. An example of this is the Randi programme with its Scandinavian aesthetics.



The planner can use highlight design to add accents – on the door handle, for example, with Wing from Randi.

Door handles are a functional interface between people and architecture. Hardly any object is taken into the hand as frequently in everyday life or establishes such a direct relationship to the building. **Accordingly, we pay great attention to the design of these functional elements, which are in dialogue with highly sensitive palms and fingers.**

Their ergonomics and haptics are therefore decisive to how they are perceived and remembered. The Randi Wing lever handle, for example, which has won several design awards, is distinguished by a shape reminiscent of the profile of an aircraft wing. The gripping hand caresses the noble metal of the handle just as the airflow caresses a wing.

The surface texture is also important: whether it is satin stainless steel, smooth shiny brass or raw, unpolished materials whose appearance ages along with the building. The Randi product range even offers wood, birch bark or high-quality plastic as materials.

And ECO Schulte shines in the core product range of the brand with a wide range of individual surfaces in all product segments, made achievable through the technology of a robust PVD coating.

Highlight design from ECO Schulte stands for fresh aesthetics, diverse options for customisation, and – like the Danish design of Randi – often is in fact a fresh trade secret for insiders.

BESPOKE DESIGN

INDIVIDUAL

DESIGNS FOR

ARCHITECTURES

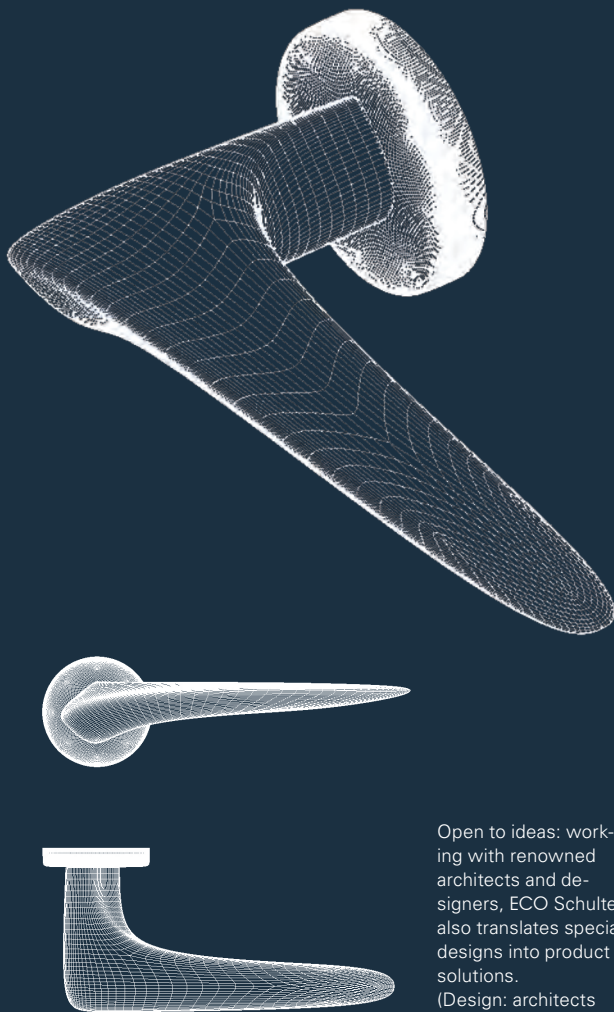

Open to ideas: working with renowned architects and designers, ECO Schulte also translates special designs into product solutions. (Design: architects Wannenmacher + Möller)

Designing a bespoke lever handle gives architects and designers enormous freedom: It allows them to influence the overall architectural coherence down to the last detail.

The Danish door handle specialist Randi – part of the ECO Schulte network – offers architects and the door industry the opportunity to develop **individual, bespoke solutions**. Randi has a long tradition in “authored” design; time and again, successful series products have been created from what began as a unique specimen.

The experts at Randi Manufaktur examine the design while **considering efficiency**, the ergonomics of the door concept, and the relevant standards.

After a graphic visualisation of the design, **3D models** are produced to test the ergonomics and haptics. The **individual door handle** is not produced until all properties, materials and surfaces have been optimised and harmonised.



DESIGN PRIZES

GUIDE TO FORM AND FUNCTION

Like a seal of quality, design awards denote user-friendliness and excellent design and **provide aesthetic guidance in the jungle of the market.** Internationally renowned expert juries have reached their decision: iF Design Awards, German Design Award, red dot and the Iconic Awards nominate premium design and distinguish outstanding products for their added aesthetic value, functional utility and utmost manufacturing quality – including the Randi Wing door handle, the ECO Newton door closer, the ECO OBX door hinge series, the EPN 2000 II panic push bar and the ECO hold-open system – to name just a few examples.



reddot design award
winner 2012



product
design award
2012



reddot design award
winner 2010



Randi

→ bit.ly/2QficUw



ECO

→ bit.ly/2LPD5oD

DESIGNING stands for purposeful use of design in architecture: from classic door handles to bespoke design by Randi. You can find more information here on our website.



NETWORKING

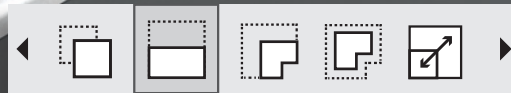

↔	55,44
↕	64,00
↶	44,30
⚡	90,00°

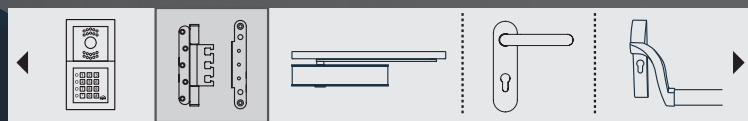

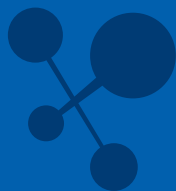

How electronic should your door be?

Architecture goes Internet: The door is one of the central issues in building management systems (BMS), as is the decentralised use of electronics. Together with our partners, ECO Schulte offers open-interface solutions for individual needs. We guarantee you a future-proof solution.

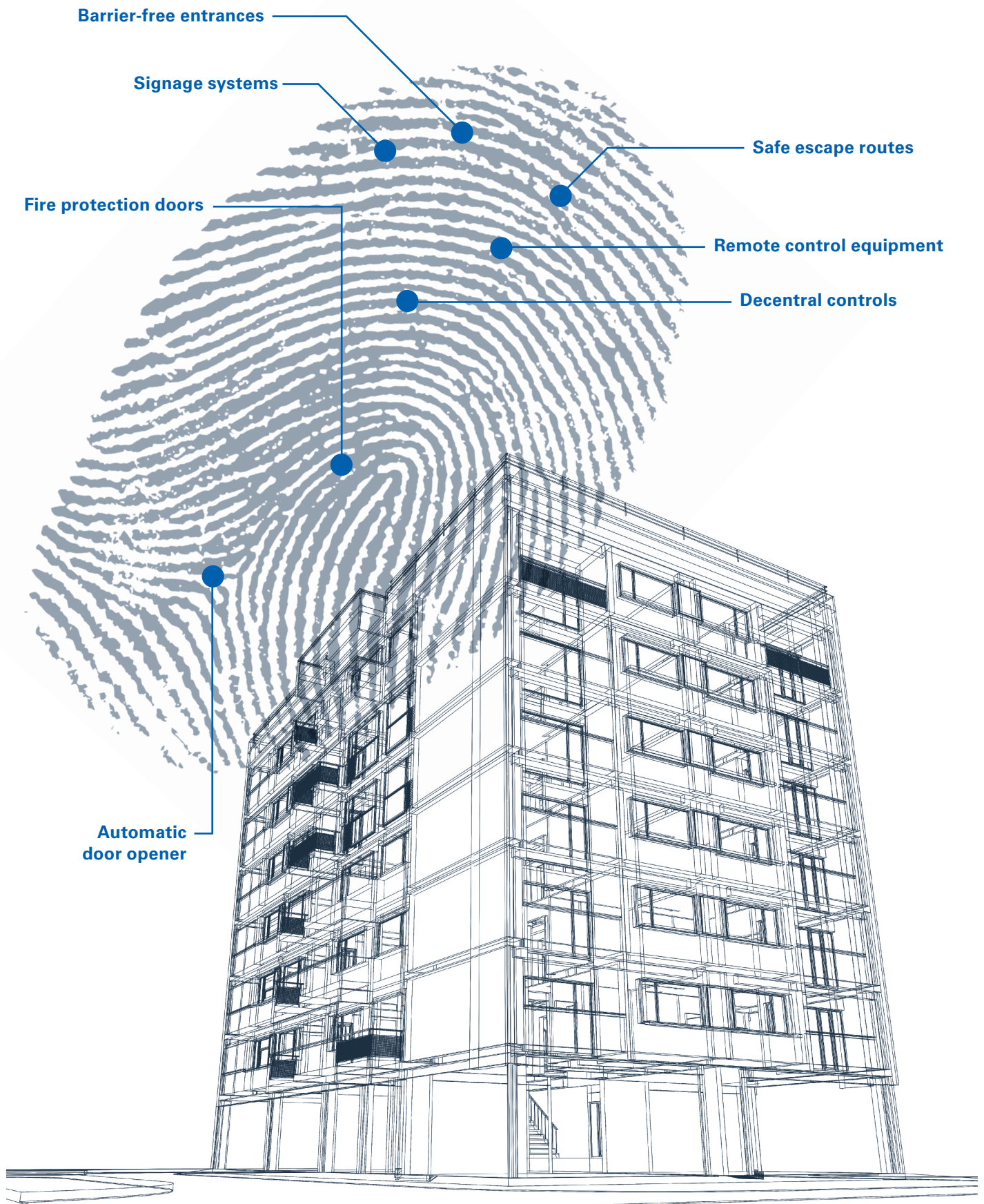



ITM – INTELLIGENT DOOR MANAGEMENT

ALL OPTIONS ARE OPEN

Doors control access into and within a building. What could be more logical than automating this access or even integrating it into the building management system? Visitor flows can be more effectively controlled and monitored this way – in all situations, in everyday operations as well as in emergencies.

Mechanics, mechatronics and IT are merging at our company under the name **ITM – Intelligent Door Management**, which is producing revolutionary complete packages with corresponding **engineering and service products**.

ITM – solving complex tasks

Each building is a highly individual project that reflects the use, needs and aesthetic values of its owners and users. By extension this means that behind every door there is an extensive catalogue of requirements made up of user needs and security architecture. **Only networked doors can articulate a response to increasingly complex demands.**

But this complexity requires specialists in every sub-section. ECO Schulte is fully committed to upholding the **expertise of the specialist** and to concentrating on its core business. We cooperate closely with other medium-sized specialist enterprises to tackle the challenges of complexity.



From multi-storey car parks to clinics and from offices to banks: the level of door networking must be developed individually for each building.

STAND ALONE DECENTRALISED – AND SECURE

Networking can occur at various levels: at the door itself, functions can be implemented without an overarching communication structure.



Decentralised applications regard the door as an autonomous functional area and **enhance its mechanical core function with convenience or control features, or with additional security elements**. These are particularly popular for smaller properties, commercial enterprises, surgeries or smaller educational institutions.

At the door, they are primarily aimed at security functions. Examples include access controls, alarms, smoke ventilation and fire protection. ECO Schulte offers solutions for this which we have put together with the product ranges of our cooperation partners to create complete packages that fulfil every possible need.

Cost-effective and uncomplicated yet secure: decentralised solutions enhance doors with convenience and security functions; as here in a shopping mall.

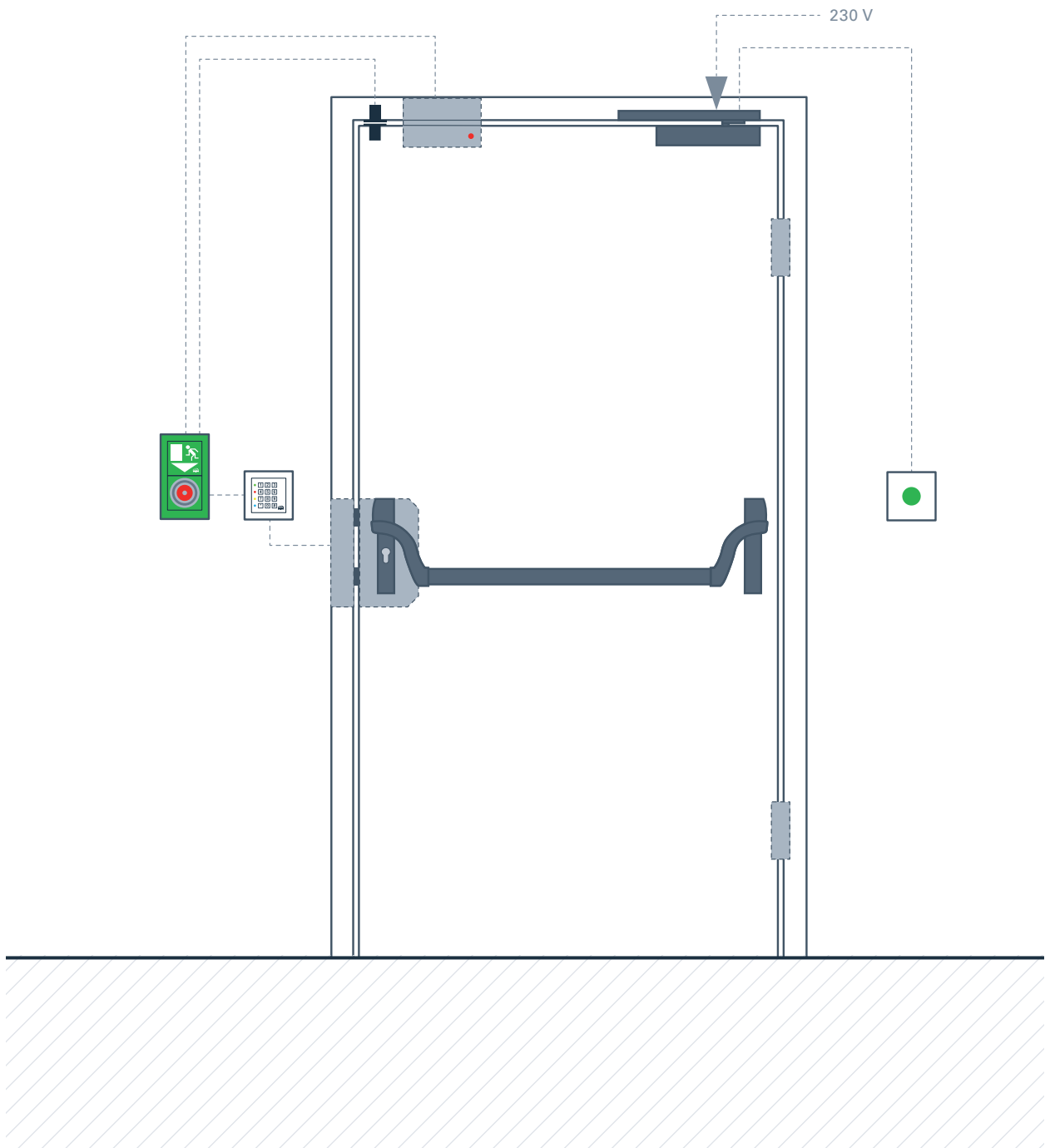
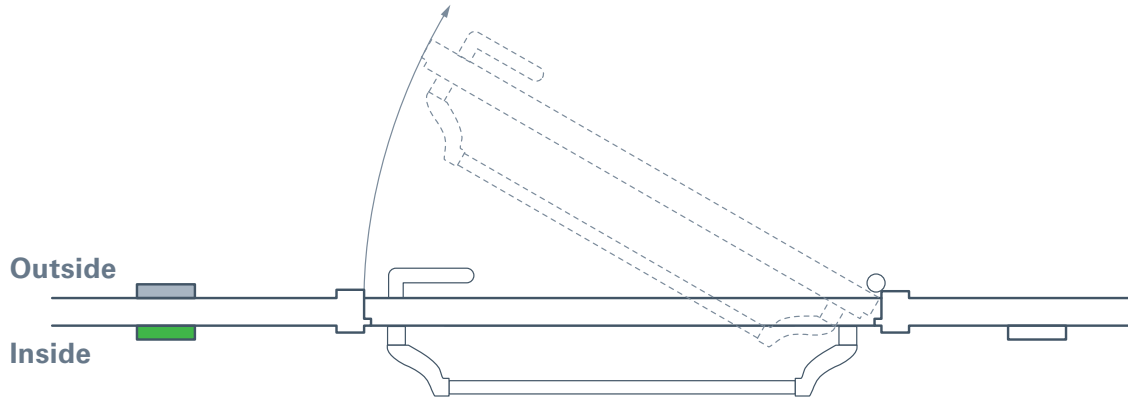

FULLY NETWORKED SYSTEMS

SMART DOORS

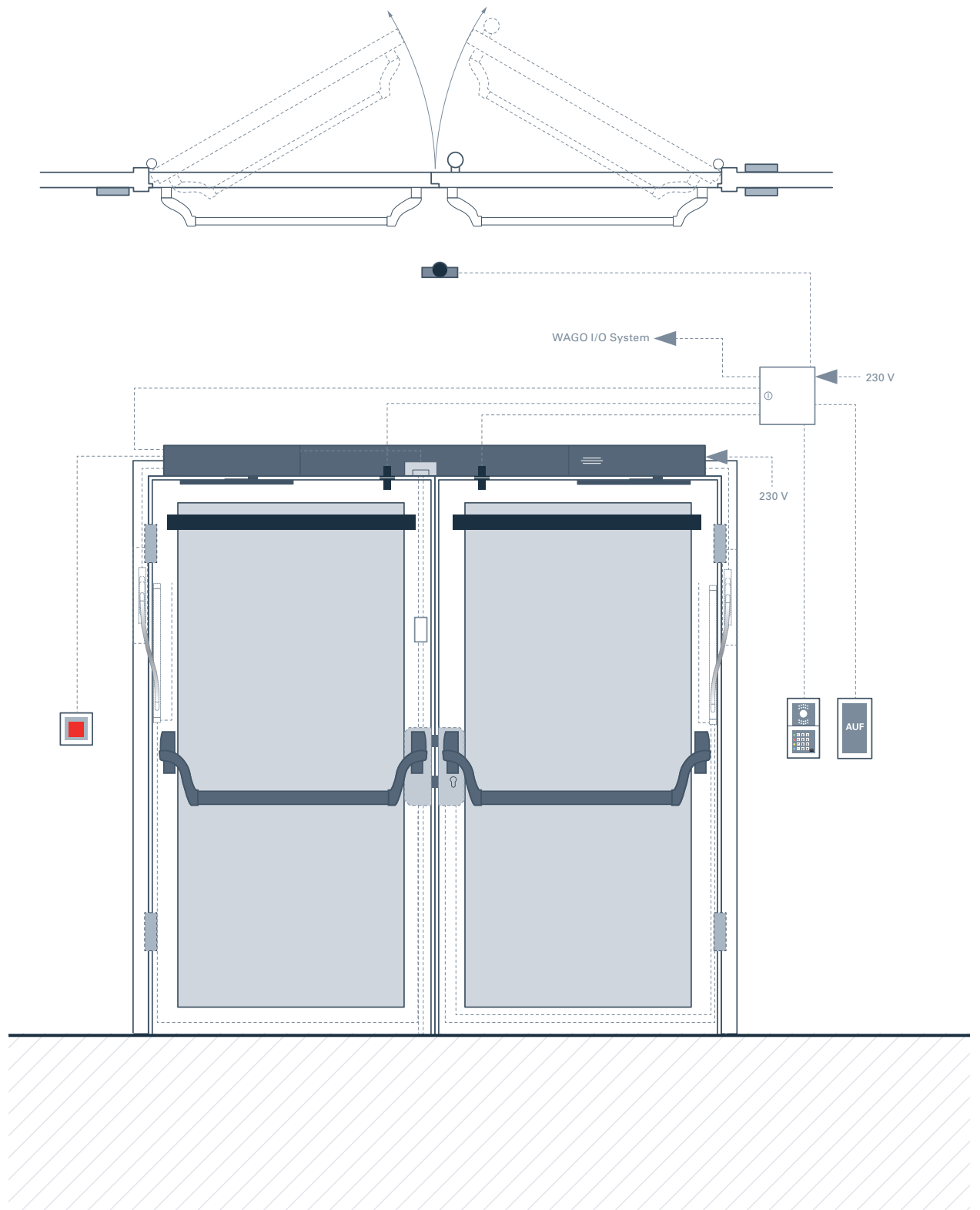



The future belongs to intelligent architecture: the larger the building, the more challenging the requirements of the building management system. New planning standards such as building information modelling (BIM) prescribe rules, give buildings transparency – and naturally do not stop at the door.

Building automation and higher levels of networking are required above all in industry, office buildings, hotels, clinics and large residential complexes. At ECO, we place a high priority on **open-interface integration** of door hardware into the building management system. We also formulate **package solutions** with our partners, who are all specialists in their fields.

These packages manage crisis situations as well as everyday routines. They enhance **security, user comfort, and efficiency**. They display the door within the building infrastructure and create control instruments.

ECO Schulte **sees itself as a moderator of all network-connected technologies on the door**: we design and develop solutions and coordinate interfaces for smooth development of the best, needs-based solution.



Fully networked door systems are required in building complexes such as clinics – they achieve security, comfort and efficiency.

NETWORKING stands for integration of doors into digital systems – networked or stand-alone. You can find more information here on our website.



ECO

→ bit.ly/2Ra00OI



DEVELOP

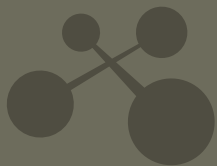

We continue developing for you

We address the “development” service to door manufacturers, regardless of whether they are industrial or manufacturing businesses: there is always something that can be improved or developed. As a manufacturer, we pay strict attention to subsequent producibility under economical conditions.



HOPEING



gerfertigt aus Stütz Zahnrad Fa. Madler Art. Nr. 26201400

ECO
58883 Madler

ECO Schalle GmbH & Co. KG
Postfach 205
58883 Madler

Abstand:
Nennkreis:
DIN 602 2108-10K

Datum: 19.05.2017
Gezeichnet: [Name]
Geprüft: [Name]

Diese Zeichnung darf ohne
Zustimmung nicht kopiert,
für Auslieferung ausgetrennt
werden. (Gem. § 588 II, BGI 9)

ED 0054-22077
Zahnradnummer:
Stütz Zahnrad V ertill.
Zl. Anzahl:

Blatt	In Bearbeitung	Gezeichnet	Geprüft
1			
2			
3			
4			
5			
6			
7			
8			
9			
10			
11			
12			
13			
14			
15			
16			
17			
18			
19			
20			

1. D 20 1
1.5 D 1
0.5 KMS

A large, stylized gear logo is positioned at the bottom right of the document. The gear is dark brown with a circular center and several teeth. It is placed over the technical drawing area.



Example 1 – Plastic fire protection fitting: In the 1970s, this idea replaced the cast steel fitting on steel doors in the cellar that was the market standard at the time.

SYNERGIES **WE LOVE DOORS**

A fruitful network of experts: ECO Schulte has been working with the door industry – and developing hardware solutions for it – for more than 50 years.



Example 2 – Spring hinges: ECO Schulte develops individual spring hinges for various door types. Today they are produced in large quantities using innovative laser welding technology.



Example 3 – The EN 1125 system: ECO Schulte develops and produces individual and coordinated panic systems for the door industry.

It began with steel doors in the cellar – and laid the foundation for **decades of solution-oriented research and development efforts**. One of the first plastic fire protection fittings comes from ECO Schulte. This version of the lever handle, with its obvious advantages, has established itself. The first chapter of an idea's success story has been written – and will be continued...

Since then, door manufacturers have been consulting with ECO Schulte due to the company's superior development and problem-solving capabilities: these collaborations have produced handles, hinges, locks, closers and fittings of all types. We know what we

are talking about because the door is the focus of our expertise – and this is precisely what is prized by our partners in the door industry as well as those who are contractors. But our expertise reaches even further: As a **company with its own production**, ECO Schulte can guarantee development of solutions that are not only functional, secure and compliant with standards – but especially that products can also be produced economically. The manufacturing competence of ECO Schulte, with its own factories and the market proximity, guarantees **innovations** and results that can then also prevail in the market in tough competition.



IDEAS ON DEMAND

If a hardware problem with a door cannot be solved with existing products, the expertise of ECO Schulte is required. An interview with development manager Michael Geven.

There is always something to improve or to develop from scratch – but where do the ideas come from, and the inspiration?

Geven: The initiative for development projects often comes from external sources when industrial customers or larger property developers come to us with ideas or specific problems. If the framework conditions – that is, the numbers – are right, then we start with preparation of specifications.

Numbers are an important keyword. In the end, the resulting product must be competitive ...

Geven: We benefit here from the fact that we can rely on a broad production base. We already know pretty well in advance what costs will be incurred up to the point the finished product is ready. Profitability calculations are the lynchpin of every product development project. We have our own machines or reliable suppliers for most manufactu-



ring processes. Depending on the expected quantities, we select the optimum manufacturing process. This is the basic formula for the producer – and we are masters at it: For small lot sizes of perhaps 50 per year, electrical discharge machining is often the method of choice. With four-digit production figures, laser cutting, milling or turning are often the cheapest, and so on... Our experience has enabled us to play this theme like virtuosos.

Could you give us some specific examples of development projects customers have requested?

Geven: A big project that has followed me since I joined ECO Schulte as a developer in 2010: a door manufacturer wanted to switch to dual sourcing for its procurement – that is, to build up a second supplier in order to optimize supply security and costs. This resulted in a development project for fire protection and panic locks that now comprises hundreds of different products. Investments in the seven-figures have thus far been made in this project for development and production technology – and they turn a profit.

Efficiency issues are often involved

Reliable calculations for the purchase quantities naturally makes the decision for such investments easier. But what if functional solutions are required?

Geven: Think of the ECO EPN 950 panic push bar. The lever arms of this lock are highly cranked, which allows enough space for installation of electronic locking cylinders. The spherical bearings for the lever arm are also specially cranked for tubular frame doors where the frames need to be as narrow as possible. Our customers had informed us that such doors are often subject to jamming when they are opened. That problem is solved with the EPN 950. And it sells very well.

How does it work with projects that are initiated internally?

Geven: Often these are not new products at all but are efficiency issues that make our products more competitive. This involves improved manufacturing processes, new materials, tools or optimization of purchasing, which customers don't notice at all. New standards also frequently initiate development projects. But we are represented as manufacturers in almost all important standards committees – I myself am involved with locks and panic fittings, for example – and so we know in advance the direction in which the system of standards is likely to develop.



The development department at ECO Schulte is concerned not only with new products but also with optimizing manufacturing processes and improving details.

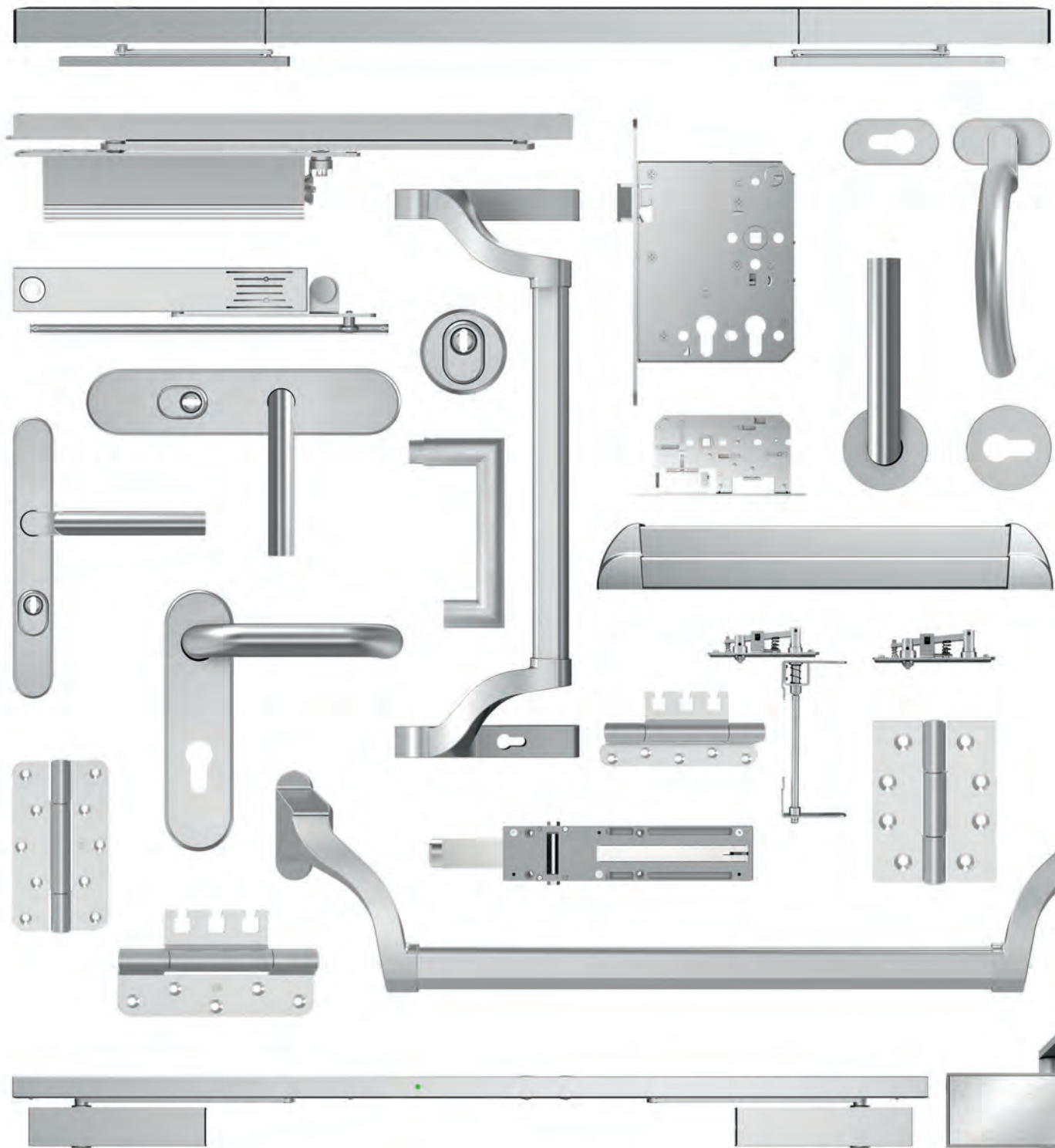

Inspired products: All these products have been optimized to meet market requirements or customer requests, either as a whole or in essential details. The ideas for this came from the development department.

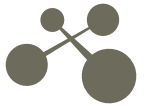

FORGING CREATIVITY

ALMOST EVERYTHING – EXCEPT DOORS

Some innovations – from little-noticed details to life-saving features – were developed by ECO Schulte for the doors of the world. It happens often enough: if a problem arises in the world of doors, people turn to Menden.

It all started with the steel door and turned into a success story: time and again, ECO Schulte has solved problems, advanced developments and improved the security, functionality and design of door hardware.



ECO

DEVELOPING stands for problem-solving expertise when it comes to hardware on the door – for the door industry and assemblers. You can find more information here on our website.

→ bit.ly/2F5vwcg



THE WORLD ECO SC



■ SYSTEM TECHNOLOGY FOR THE DOOR

WORLD OF SCHULTE



ECO Online



ECO

ECO Website

→ bit.ly/2LL9D39

SAFETY IS INTEGRAL

THE ECO SYSTEM

Door closer technology

Hinge technology

Conference
Room

**Intelligent
door management**

Fitting technology



Panic & locking technology

The world of ECO Schulte is door technology. As one of only a very few system suppliers worldwide, the company takes a holistic approach. In close cooperation with door manufacturers and processors in the trade, the door-related technologies are developed and constantly honed round the clock. ECO never only focuses on the individual product, but rather on the interplay between all components in the door system. From the door closer to the hinge, from the lock to the fitting. The door is a complex safety structure: it protects life and limb – and values. All valuable – and deserving of best quality and maximum functional safety. **In all things door-related, the best is good enough – ECO Schulte.**



AESTHETIC POWERHOUSES. DOOR CLOS TECHNOLOGY

■ SYSTEM TECHNOLOGY FOR THE DOOR

SER
Y



To the product range



ECO

ECO Website

→ bit.ly/2CJKKC7



ECO

ECO Finder

→ bit.ly/2CJdhYq

DOOR CLOSERS WITH SLIDE RAIL

ECO **NEWTON**



Types of doors



Material



Tests / standards



ECO **Newton** TS-62
(EN 2 – 5)



ECO **Newton** TS-61
(EN 2 – 5 / EN 5 – 6)



ECO **Newton** TS-51
(EN 1 – 4)



ECO **Newton** TS-41
(EN 1 – 4)



ECO **Newton** TS-31
(EN 1 – 3)



SLIDE RAILS

SURFACE-MOUNTED



Types of doors



Material



Tests / standards



Slide rail SR-EFR-2 with ECO **Newton** door closer TS-61



Slide rail EFR with ECO **Newton** door closer TS-61

Slide rails for single-leaf doors

- Slide rail GS B
- Slide rail GS B-FKL
- Slide rail EF
- Slide rail EF BG

Slide rails for single-leaf doors with integrated smoke detector

- Slide rail EFR (short)
- Slide rail EFR BG

Slide rails for double-leaf doors

- Slide rail SR
- Slide rail SR BG
- Slide rail SR-EF-2
- Slide rail SR-EF-2 BG

Slide rails for double-leaf doors with integrated smoke detector

- Slide rail SR-EFR-2
- Slide rail SR-EFR-2 BG

B = Basic, BG = Push side, GS = Slide rail, EF = Electromagnetic hold-open, EFR = Electromagnetic hold-open with smoke detector, FKL = Spring clamp, SR = Closing sequence control

DOOR CLOSERS WITH ARM ECO **NEWTON**



Types of doors



Material



Tests / standards

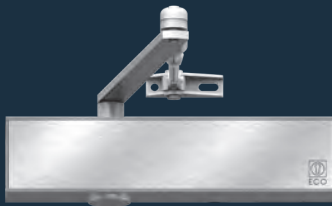

ECO **Newton** TS-50
(EN 2 – 6)

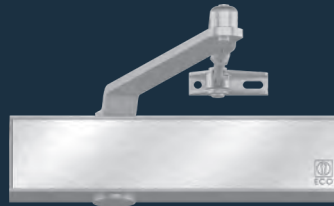

ECO **Newton** TS-20
(EN 2 / 3 / 5)

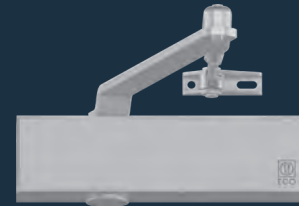

ECO **Newton** TS-14
(EN 2 / 3 / 4)

FREE-SWINGING DOOR CLOSERS ECO **FTS**

Types of doors



Material



Tests / standards



FTS-63
(EN 1 – 4 / EN 5 – 6)



FTS-63 R
(EN 1 – 4 / EN 5 – 6)

ER = Stainless steel, AI = Aluminium
R = Integrated smoke switch



INTEGRATED DOOR CLOSERS

ECO ITS

Types of doors



Material



Tests / standards



ITS 420
(EN 2 – 4)



ITS 630
(EN 3 – 6)

SLIDE RAILS

INTEGRATED

Types of doors



Material



Tests / standards



Integrated slide rails for single-leaf doors

Slide rail IS
Slide rail IS-EF



Integrated slide rails for double-leaf doors

Slide rail IS-SR
Slide rail IS-SR-EF

IS = Integrated rail, EF = Electromagnetic hold-open, EFR = Electromagnetic hold-open with smoke detector,
SR = Closing sequence control

THE AESTHETE ECO **NEWTON**

The door closer generation from ECO Schulte: a meticulously well-conceived design consisting of a **stainless steel cover** and aluminium body. **Concealed mounting plates**, setting elements protected against vandalism, colour-coordinated materials and the variable combination of all slide rail door closers with the closing sequence control systems characterise this generation of door closer models. In addition, the **new valve technology ECO VALVE** guarantees the simple and highly **precise adjustment** of all parameters of the closing process.



ECO **Newton** TS-61



THE SYSTEM OVERVIEW

ECO NEWTON

Door closers with slide rail							
Designation	Tests ¹	Size acc. to EN ²	Latching speed adjustment ³	Back-check ⁴	Closing speed adjustment	Closing delay ⁵	DIN L + R / BS + BG ⁶
TS-62	/	2-5 continuously	from the front	adjustable	from the front	adjustable	yes / yes ⁷
TS-61	/	5-6 continuously	from the front	adjustable	from the front	–	yes / yes ⁷
TS-61	/	2-5 continuously	from the front	adjustable	from the front	optional	yes / yes ⁷
TS-51	/	1-4 continuously	from the front	adjustable	from the front	–	yes / yes ⁷
TS-41	/	1-4 continuously	from the side	fixed	from the side	–	yes / yes
TS-31	/	1-3 continuously	from the side	fixed	from the side	–	yes / yes

Standard arm closers							
Designation	Tests ¹	Size acc. to EN ²	Latching speed adjustment ³	Back-check ⁴	Closing speed adjustment	Closing delay ⁵	DIN L + R / BS + BG ⁶
TS-50	/	2-6 continuously	from the side	fixed	from the side	–	yes / yes
TS-20	/	3 / 5	from the side	fixed	from the side	–	yes / yes
TS-14	/	2 / 3 / 4	from the side	–	from the side	–	yes / yes

1) EN 1154 – CE-mark and fire-protection tested **2)** Door closer sizes acc. to European Norm (EN) **3)** Increases the closing speed just before closing to ensure the door closes reliably **4)** Regulates the force necessary to open the door (check) from 70° opening angle **5)** Regulates the closing speed (delay) of the door up to 70° opening angle (e.g. for barrier-free passage) **6)** Left and right-hand installation (L+R) possible, as well as for pull side (BS) or push side (BG) **7)** Please order BG (= push side) version

THE HIGHLIGHTS

ECO **NEWTON**



ECO **UNITY**

Two bodies for the whole building.

The ECO **Newton** door closer portfolio covers all door dimensions with only two basic units. In addition, end-mounted valve technology permits the door closer to be installed on the pull and push side in normal or transom installation (TS-41/31).



ECO **PHYSIS**

Combination of elegant materials

Elegant materials are standard with ECO **Newton**: The stainless steel cover and aluminium body unit of the new door closer generation are perfectly matched with one another – in an architecturally compatible form language.

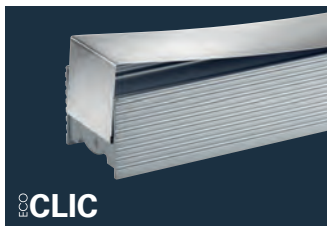

ECO **CLIC**

Intelligent stainless steel cover

ECO **CLIC** envelops the aluminium body unit with the power of spring steel. The cover conceals all of the adjusting elements and cannot be removed without tools, thus securing the closer against unauthorised access.



ECO **MOUNT**

Well-conceived assembly system

The special feature of the ECO **Newton** assembly system is that the mounting plate is completely concealed by the aluminium body of the closer, thus making it invisible. The mounting plate has standardised drill holes which guarantee time-saving, secure and straightforward attachment.



ECO **VALVE**

Innovative valve technology

The new ECO **VALVE** valve technology offers a wide and precisely adjustable setting range. This means the simple, high-precision and permanently secure adjustment of all parameters of the closing process using a conventional Allen key. As with all ECO **Newton** door closers, the closing speed and latching speed are regulated via the ECO **VALVE** as a standard feature. An additional valve stop prevents the valves being overtightened or screwed out.



Stainless steel full cover

The full cover is an optional stainless steel cover for the ECO **Newton** door closer and the respective slide rail. The overall appearance is perfected by a lever arm with a stainless steel finish. A cover on the closer body is available for standard arm closers.

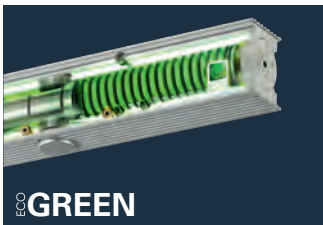

Saves resources

ECO **Newton** door closers are up to 1,000 grams lighter than comparable solutions. Their intelligent construction and carefully planned use of materials make a considerable contribution to saving resources – without compromising functionality, safety, security or quality.



Uniform finishing edge and colour design

The mounted slide rail and door closer are flush when the door is closed. All materials are perfectly colour-matched – right through to the end caps on the slide rail. In this way, ECO **Newton** door closers can be integrated harmoniously into every design context.



Combination talent

The ECO **Newton VARIO** concept permits the use of all slide rail door closers and can even be combined with different door leaf widths. In this way, optimum value for money can be achieved for each individual door situation.



Standardised quality

As with all ECO Schulte products, the door closers are manufactured in a quality management process certified in accordance with ISO 9001. This guarantees that top quality is produced and installed. Many door closer variants are suitable for use on fire and smoke protection doors – and tested in accordance with **EN 1154**. All products which are tested in accordance with valid European directives are identified by the CE mark.



THE CHOREOGRAPHY OF SAFETY

Door hold-open systems are highly complex and were developed to hold fire and smoke protection doors open during daytime operation and to close them accordingly in the event of fire / smoke development to separate the fire sections reliably. A precisely defined closing sequence is prescribed for double-leaf doors: the passive leaf must close first, then the active leaf. A choreography of safety developed to save human life.

SYSTEM OVERVIEW

ECO HOLD-OPEN SYSTEMS

Single-leaf systems

Designation	Tests ¹	Function	Max. leaf width	Max. hold-open angle	Type of installation ²
EF	F / CE	Electromagnetic hold-open device (24V)	1,400 mm	130°	BS
EF-BG	F / CE	Electromagnetic hold-open device (24V)	1,250 mm	110°	BG
EFR	F / CE	Electromagnetic hold-open system with integrated RM (230V)	1,400 mm	130°	BS
EFR-BG	F / CE	Electromagnetic hold-open system with integrated RM (230V)	1,250 mm	110°	BG

RM = Smoke detector

1) EN 1155 – CE mark and fire protection authorisation 2) BS = Pull side / BG = Push side

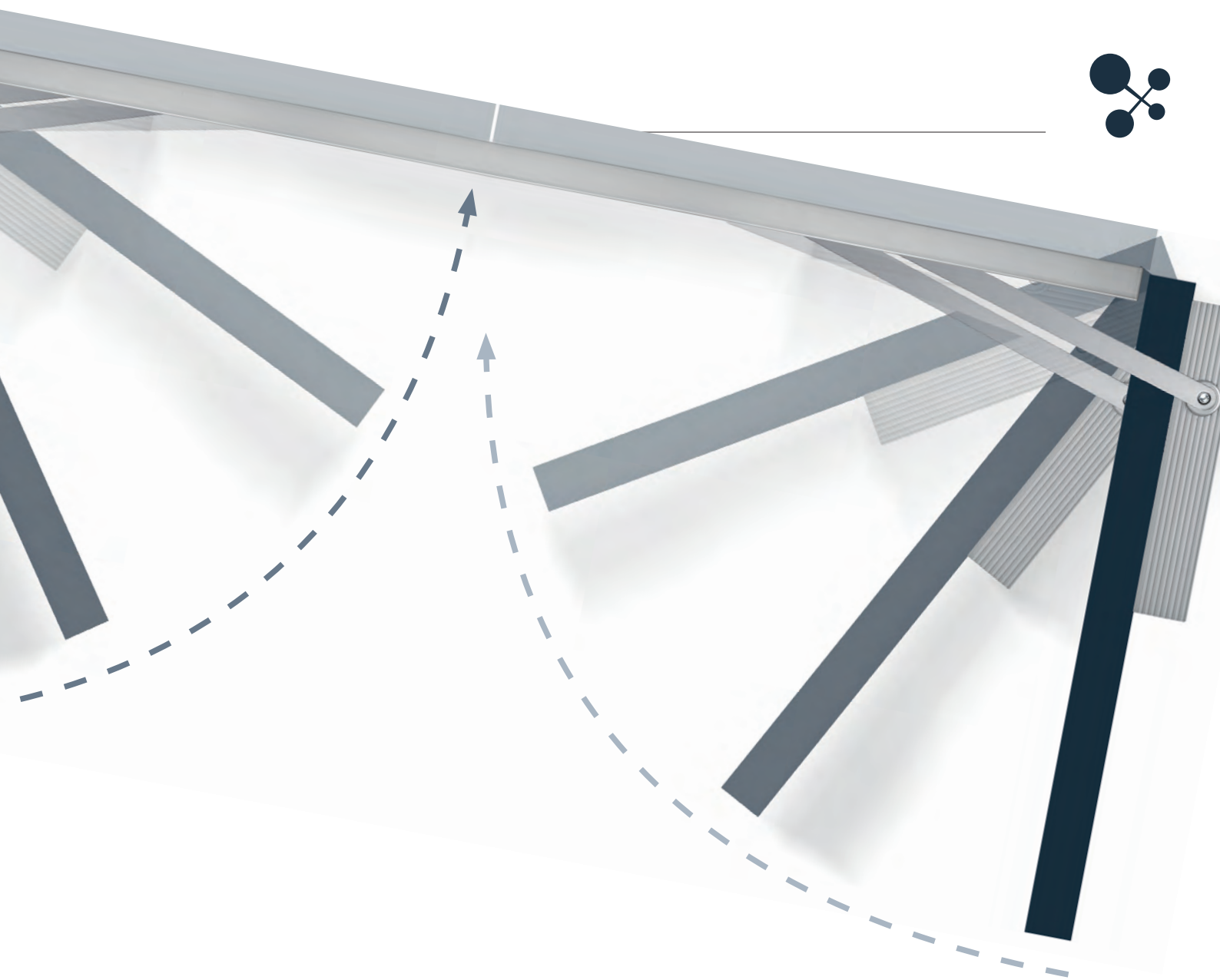

Double-leaf systems

Designation	Tests ¹	Function	Max. leaf width	Max. hold-open angle	Type of installation ²
SR	F / CE	Closing sequence control	2,800 mm	–	BS
SR-BG	F / CE	Closing sequence control	2,500 mm	–	BG
SR-EF	F / CE	SR with hold-open device (24V)	2,800 mm	130° / 130°	BS
SR-EF-BG	F / CE	SR with hold-open device (24V)	2,500 mm	110° / 110°	BG
SR-EFR	F / CE	SR with hold-open system with integrated RM (230V)	2,800 mm	130° / 130°	BS
SR-EFR-BG	F / CE	SR with hold-open system with integrated RM (230V)	2,500 mm	110° / 110°	BG



■ SYSTEM TECHNOLOGY FOR THE DOOR

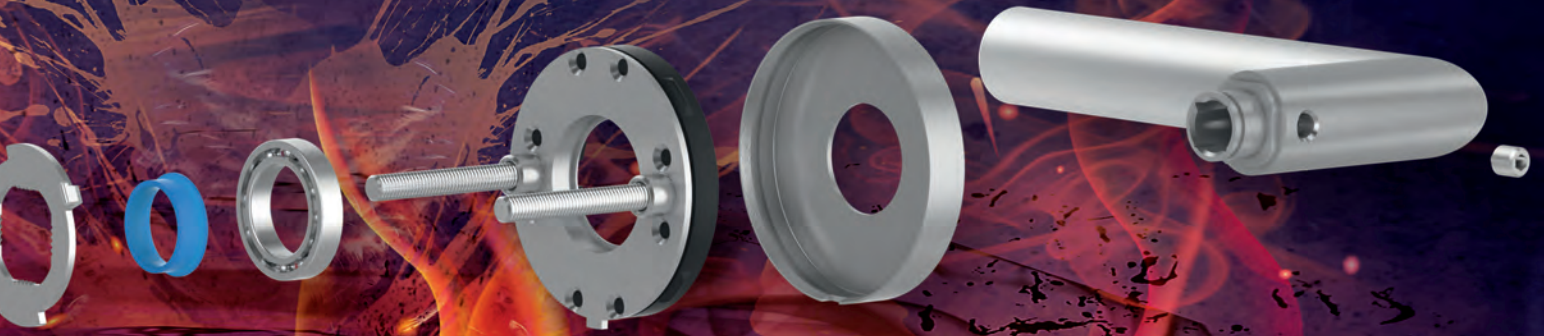

LATCHING
ON TO THINGS.

FITTING
TECHNOLOGY

To the product range

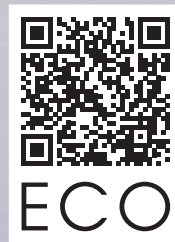

ECO Website

→ bit.ly/2s5hKhR



ECO Finder

→ bit.ly/2AnSgRh

ROSE HANDLES (ROS) SHORT PLATE HANDLES (K) LONG PLATE HANDLES (L)

Types of doors



Material



Tests / standards



Bearing technologies



Rose handle
D-110

EN 179



Rose handle
D-120

EN 179



Rose handle
D-190

EN 179



Rose handle
D-210



Rose handle
D-310



Rose handle
D-330

EN 179



Rose handle
D-410

EN 179



Rose handle
D-490

EN 179



Rose handle
D-510

EN 179



OVAL ROSE HANDLES (OVR)

Types of doors



Material



Tests / standards



Bearing technologies



Oval rose handle
D-115

EN 179



Oval rose handle
D-116

EN 179



Oval rose handle
D-310



Oval rose handle
D-315



Oval rose handle
D-335

EN 179



Oval rose handle
D-410

EN 179



Oval rose handle
D-415

EN 179



Oval rose handle
D-515

EN 179

PROTECTIVE FITTINGS (ES 1/RC 2 ■ ES 2/RC 3 ■ ES 3/RC 4)

HANDLE PLATES

PROTECTIVE FITTINGS (ES 3)

FOR DOORS WHICH PREVENT BULLET PENETRATION (RC 4)

SPECIAL PROTECTIVE FITTINGS (ES 3/RC 4)

FOR PANIC LOCKS

COMBINED PROTECTIVE FITTINGS (ES 1/RC 2)

INSIDE WITH ROUND ROSES

Types of doors



Material



Tests / standards



Bearing technologies



Protective handle
G-140



Protective handle
G-150



Protective handle
G-160



Protective handle
G-170



Protective handle
G-180



Protective handle
G-190



Protective handle
G-200

ER = Stainless steel, Al = Aluminium



PROTECTIVE FITTINGS (ES1/RC2)

KNOBS

Types of doors



Material



Tests / standards



Bearing technologies



Protective handle
K-110



Protective handle
K-116



Protective handle
K-120



Protective handle
K-130



Protective handle
K-160



Protective handle
K-165

PROTECTIVE ROSES (ES1/RC2)

Types of doors



Material



Tests / standards



Protective rose kit
with ZA-hole



Protective rose kit
with PZ-hole

Resistance classes – burglar-resistant components to DIN EN 1627

Resistance class	Protective fittings		Resistance class	Protective fittings
RC 1N	ES 1	Alternatively	RC 1N	ES 1-ZA
RC 2N	ES 1		RC 2N	ES 1-ZA
RC 2	ES 1		RC 2	ES 1-ZA
RC 3	ES 2		RC 3	ES 2-ZA
RC 4	ES 3		RC 4	ES 3-ZA

RC = Resistance class, ES = Burglary-resistance class, ZA = Cylinder cover

OBJECT WINDOW HANDLES ¹⁾

LOCKABLE

Material

ER **AI**

Tests / standards

EN 13126-3



Object window handle
FO-110 A



Object window handle
FO-310 A



Object window handle
FO-410 A

OBJECT WINDOW HANDLES ¹⁾

Material

ER **AI**

Tests / standards

EN 13126-3



Object window handle
FO-110



Object window handle
FO-310



Object window handle
FO-410

ER = Stainless steel, AI = Aluminium

¹⁾ Also available in White, RAL 9016



OBJECT WINDOW HANDLES ¹⁾

TBT

Material

ER **AI**

Tests / standards

EN 13126-3



Object window handle
FO-110 TBT



Object window handle
FO-310 TBT



Object window handle
FO-410 TBT

WINDOW HANDLES

Material

ER



Window handle
F-110



Window handle
F-120



Window handle
F-210



Window handle
F-310



Window handle
F-410

TBT = Tilt Before Turn

TIMELESS AND ELEGANT FORMS

ECO D-100 archetype: U-shaped handle

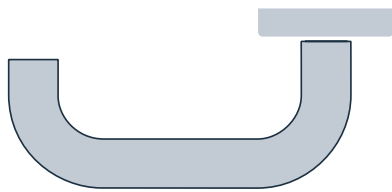

ECO D-110

Classic handle with added value: the advantage of the U-shaped handle lies in its second 90 degree bend. It was used traditionally to prevent people or material from getting “threaded on”. The rear bend of the handle helps to prevent shopping bags or coat sleeves from getting caught on the handle. In addition, the U-shaped handle has comfort qualities, because the rear turn supports the ball of the hand when the door is opened. ECO-Schulte has the U-shaped handle in its product range as factory design draft D-110.

ECO D-200 archetype: Frankfurt standard L-shaped handle

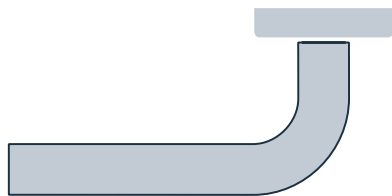

ECO D-210

In their efforts to lower house construction prices and rents in the 1920s, many architects became involved in the standardisation of construction components. The ECO D-200 is a variation of the draft that once made a name for itself as the Frankfurt standard handle where a round rod was bent by 90 degrees and positioned on a simple rose. All of the Frankfurt versions are based on the idea of the right angle. ECO-Schulte has included the Frankfurt standard handle in its product range in a high-quality modern interpretation as factory design draft D-210.

ECO D-300 archetype: Frankfurt mitred handle



ECO D-310

The ECO D-300 is a variation of a geometric handle draft design from the 1920s and stands out through the legible simplicity of the construction: a circular tube is separated with a mitred cut. The two halves are then joined together again at right angles. This handle was given the attribute “Frankfurt” not only through its close geometric relationship with the Frankfurt standard handle but also because it was used when the Frankfurt Architecture Museum was built. ECO Schulte has included its interpretation of the Frankfurt mitred handle in its product range as factory design draft D-310.



ECO D-400 archetype: Ulm handle

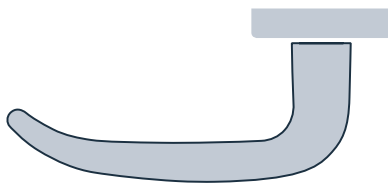

Made for getting to grips with! The archetype of this U-shaped handle was named after the Ulm School of Design where it was first used in the 1950s. The draft was based at the time on the door handles of trains run by the Swiss railway. ECO Schulte reworked the Ulm handle with its own factory design draft D-410.

ECO D-410

ECO D-500 archetype: Hand-shape handle

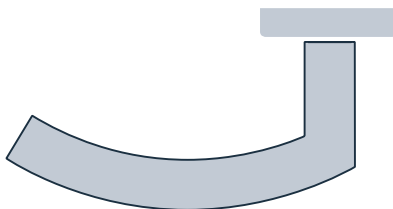

As far as the typology is concerned, this handle constitutes an ergonomic connection between the Frankfurt mitred handle and the Ulm handle. The design of this factory design draft D-510 is discreet, easy to grip and oriented towards the direction of movement.

ECO D-510

MORE THAN JUST A DOOR HANDLE

ECO **OKL MAGIS**



OKL Magis – premium object fitting with ball bearing technology

OKL bearing technology

The industrial ball bearing is characteristic for these high-quality object fittings. A precise and maintenance-free, fully encapsulated grooved ball bearing ensures the well-balanced, play-free mounting of the handle. The integrated flexible bearing compensates radial and axial clearance.

Performance criteria ECO OKL Magis

- **EN 1906**, user class 4
- **1 million test cycles**, tested to **MPA plus**
- **EN 1906**, corrosion class 5
- **DIN 18273** approved
for fire and smoke protection doors 
- **EN 179**, depending on handle shape
- **DIN-L / DIN-R** useable
- Type B restoring spring with 90° stop
- Fixed sleeve nuts + support cams
- High-precision **ball-bearing technology** with flexible compensating bearing
- High-strength pin connection
- Rose dimensions Ø 55 x 9 mm
- Standard door thickness 38-45 mm and 44-66 mm
- 8 mm / 9 mm fire protection

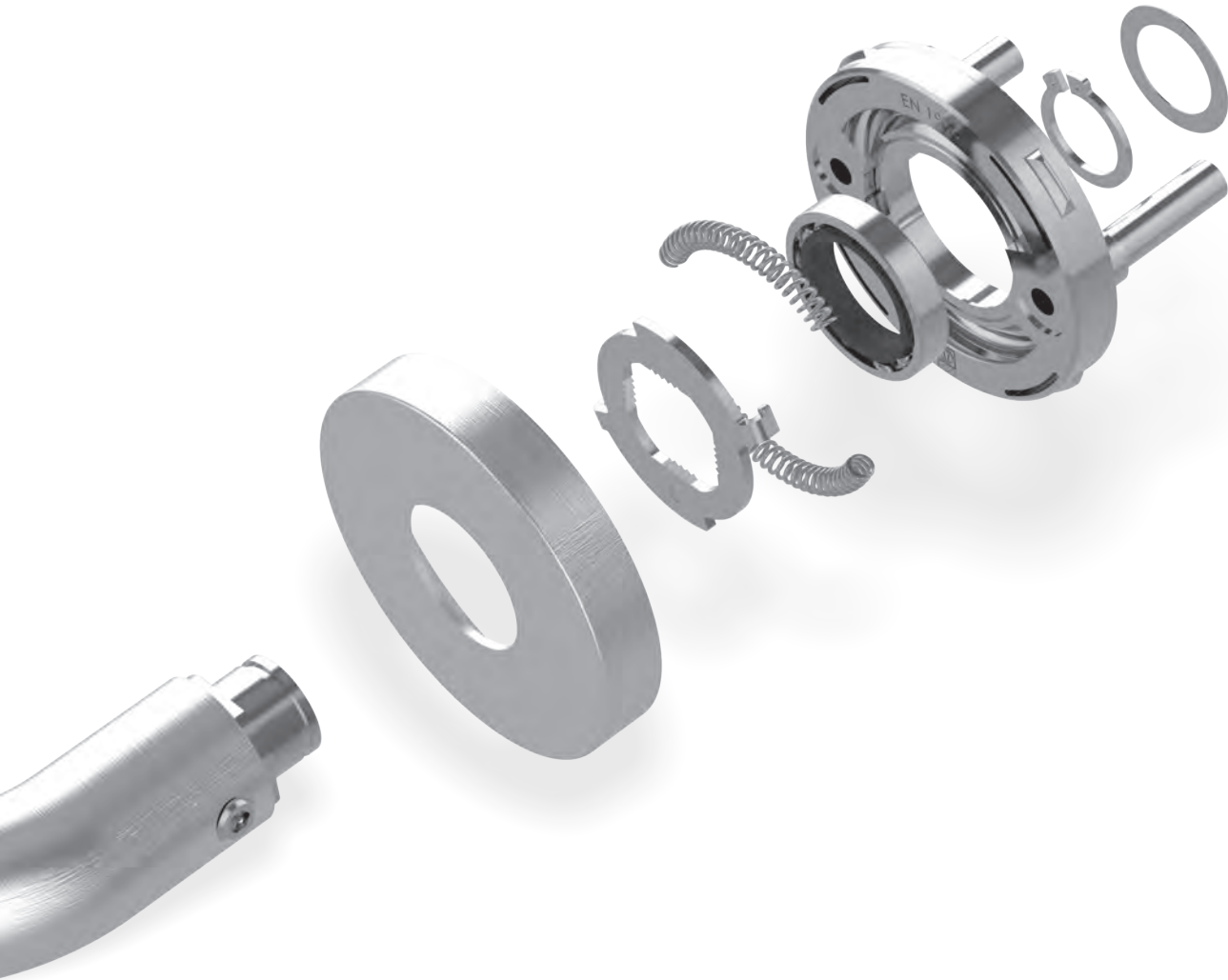

- | | |
|--|---|
| <input checked="" type="checkbox"/> PUBLIC | <input checked="" type="checkbox"/> EDUCATION |
| <input checked="" type="checkbox"/> HEALTHCARE | <input checked="" type="checkbox"/> INDUSTRY |
| <input checked="" type="checkbox"/> OFFICE | <input checked="" type="checkbox"/> RESIDENTIAL |
| <input checked="" type="checkbox"/> TRANSPORT | <input checked="" type="checkbox"/> HOTEL |

Classification key EN 1906

4	D9*	-	B1	1	5	0	B / U
---	-----	---	----	---	---	---	-------

Stainless steel version

* 1 million test cycles, tested to **MPA plus**

Material

ER

OKL Magis

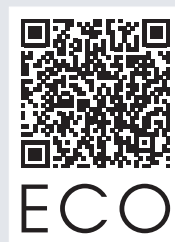

ECO

ECO Website

→ bit.ly/2TrEWml

ROSE HANDLE WITH QUICK ASSEMBLY ECO **OGL CLICK**



OGL Click – object fitting
with friction bearing technology

OGL Click bearing technology

These object fittings have a maintenance-free plastic friction bearing, which floats in the galvanized steel base rose and thus compensates the radial and axial play.

Performance criteria ECO OGL Click

- ECO **Click** quick assembly
- Damage-free removal
- **EN 1906**, user class 4
- 200,000 test cycles
- **EN 1906**, corrosion class 4
- **DIN 18273** approved
for fire and smoke protection doors **F**
- **EN 179**, depending on handle shape
- **DIN-L / DIN-R** useable
- Type A restoring spring
- Fixed sleeve nuts + support cams
- Maintenance-free handle bearing
- High-strength pin connection
- Rose dimensions Ø 55 x 9 mm
- Standard door thickness 38-45mm
and 44-66mm
- 8 mm / 9 mm fire protection

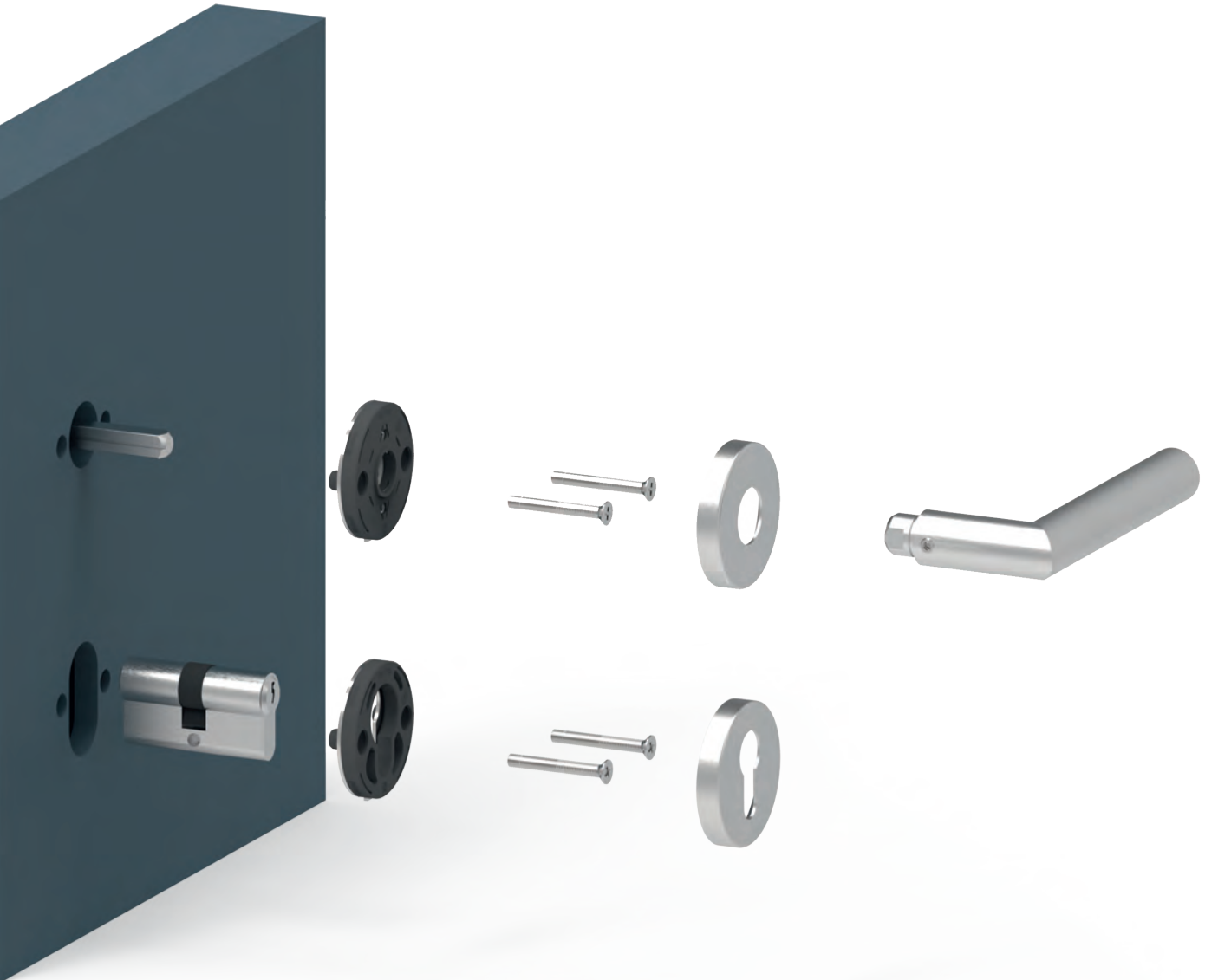

- | | |
|--|---|
| <input checked="" type="checkbox"/> PUBLIC | <input checked="" type="checkbox"/> EDUCATION |
| <input checked="" type="checkbox"/> HEALTHCARE | <input checked="" type="checkbox"/> INDUSTRY |
| <input checked="" type="checkbox"/> OFFICE | <input checked="" type="checkbox"/> RESIDENTIAL |
| <input checked="" type="checkbox"/> TRANSPORT | <input checked="" type="checkbox"/> HOTEL |

Classification key EN 1906 – OGL Click

4	7	-	B1	1	4	0	A/U
---	---	---	----	---	---	---	-----

Stainless steel version

Material

ER **AI**

OGL Click

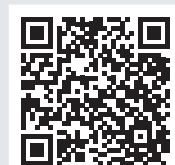

ECO

ECO Website

→ bit.ly/2TmLOBe

ROSE HANDLE WITH QUICK ASSEMBLY ECO **SGL CLICK**



SGL – object fitting
with friction bearing technology

SGL bearing technology

The lever handle is guided radially and axially in the base rose made of glass fibre reinforced plastic. Angle tolerances are compensated by a wave spring washer.

Performance criteria ECO SGL Click

- ECO **Click** quick assembly
- **EN 1906**, user class 3
- 200,000 test cycles
- **EN 1906**, corrosion class 4
- **DIN-L / DIN-R** useable
- Type A restoring spring
- Fixed sleeve nuts + support cams
- Maintenance-free handle bearing
- High-strength pin connection
- Rose dimensions Ø 55 x 9 mm
- Standard door thickness 38 - 45 mm
- 8 mm

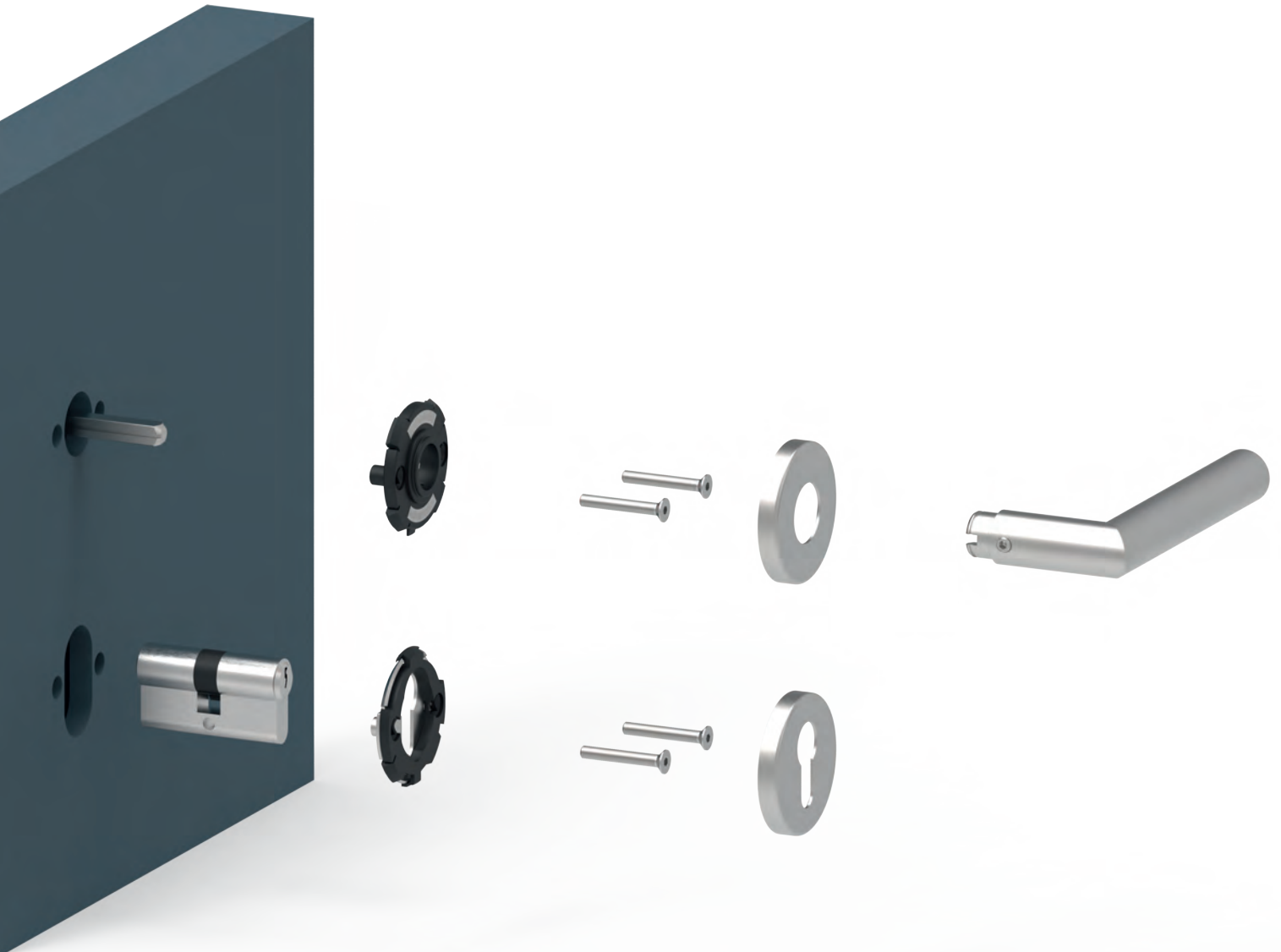

- | | |
|--|---|
| <input type="checkbox"/> PUBLIC | <input type="checkbox"/> EDUCATION |
| <input type="checkbox"/> HEALTHCARE | <input type="checkbox"/> INDUSTRY |
| <input checked="" type="checkbox"/> OFFICE | <input checked="" type="checkbox"/> RESIDENTIAL |
| <input type="checkbox"/> TRANSPORT | <input type="checkbox"/> HOTEL |

Classification key EN 1906

3	7	-	0	1	4	0	A
---	---	---	---	---	---	---	---

Material

ER AI

SGL Click

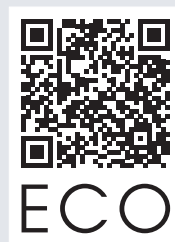

ECO

ECO Website

→ bit.ly/2LM9ywa

OVAL ROSE HANDLE (OVR)



OGL – Oval rose handle
with friction bearing technology

OGL bearing technology

These object fittings have a maintenance-free plastic friction bearing, which floats in the galvanized steel base rose and thus compensates the radial and axial play.

Performance criteria ECO OGL

- **EN 1906**, user class 4
- **1 million test cycles**, tested to **MPA plus**
- **EN 1906**, corrosion class 4
- **DIN 18273** approved
for fire and smoke protection doors 
- **EN 179**, depending on handle shape
- **DIN-L / DIN-R** useable
- Type A restoring spring
- Available with and without support cams
- Maintenance-free handle bearing
- High-strength pin connection
- Oval rose dimension 70 x 33 mm
- 8 mm / 9 mm fire protection

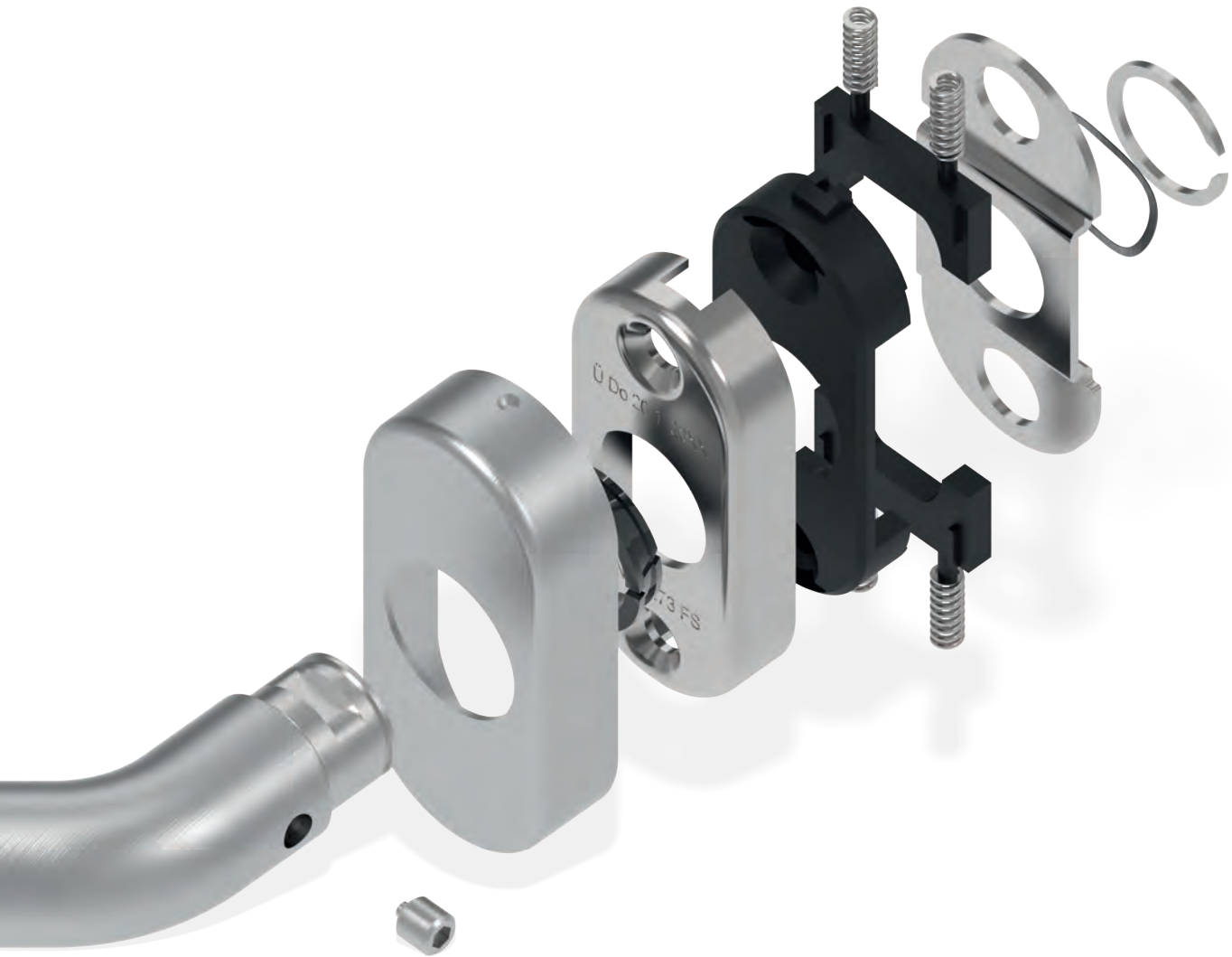

- | | |
|--|---|
| <input checked="" type="checkbox"/> PUBLIC | <input checked="" type="checkbox"/> EDUCATION |
| <input checked="" type="checkbox"/> HEALTHCARE | <input checked="" type="checkbox"/> INDUSTRY |
| <input checked="" type="checkbox"/> OFFICE | <input checked="" type="checkbox"/> RESIDENTIAL |
| <input checked="" type="checkbox"/> TRANSPORT | <input checked="" type="checkbox"/> HOTEL |

Classification key EN 1906 – OGL

4	D9*	-	B1	1	4	0	A
---	-----	---	----	---	---	---	---

Stainless steel version

* 1 million test cycles, tested to **MPA plus**

Material



OVR

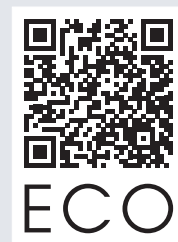

ECO

ECO Website

→ bit.ly/2Vr4S39



ALWAYS ON THE SAFE SIDE.
**PANIC & LOCKING
TECHNOLOGY**

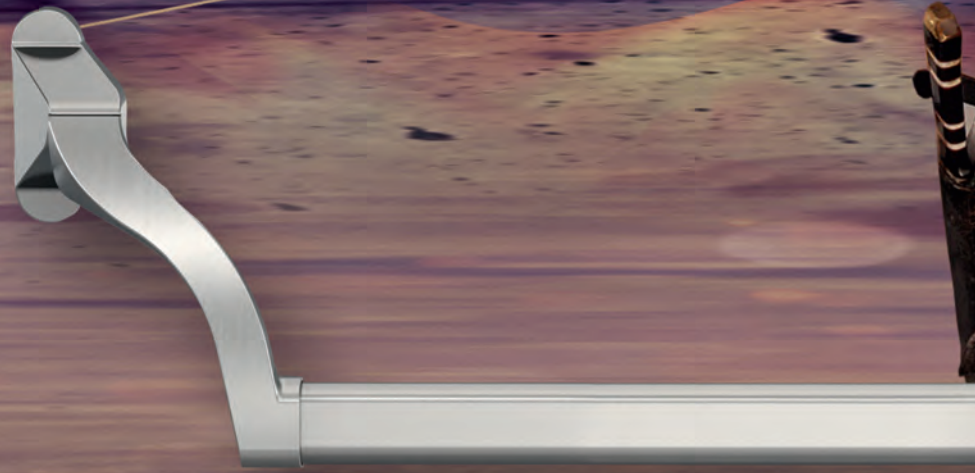

■ SYSTEM TECHNOLOGY FOR THE DOOR

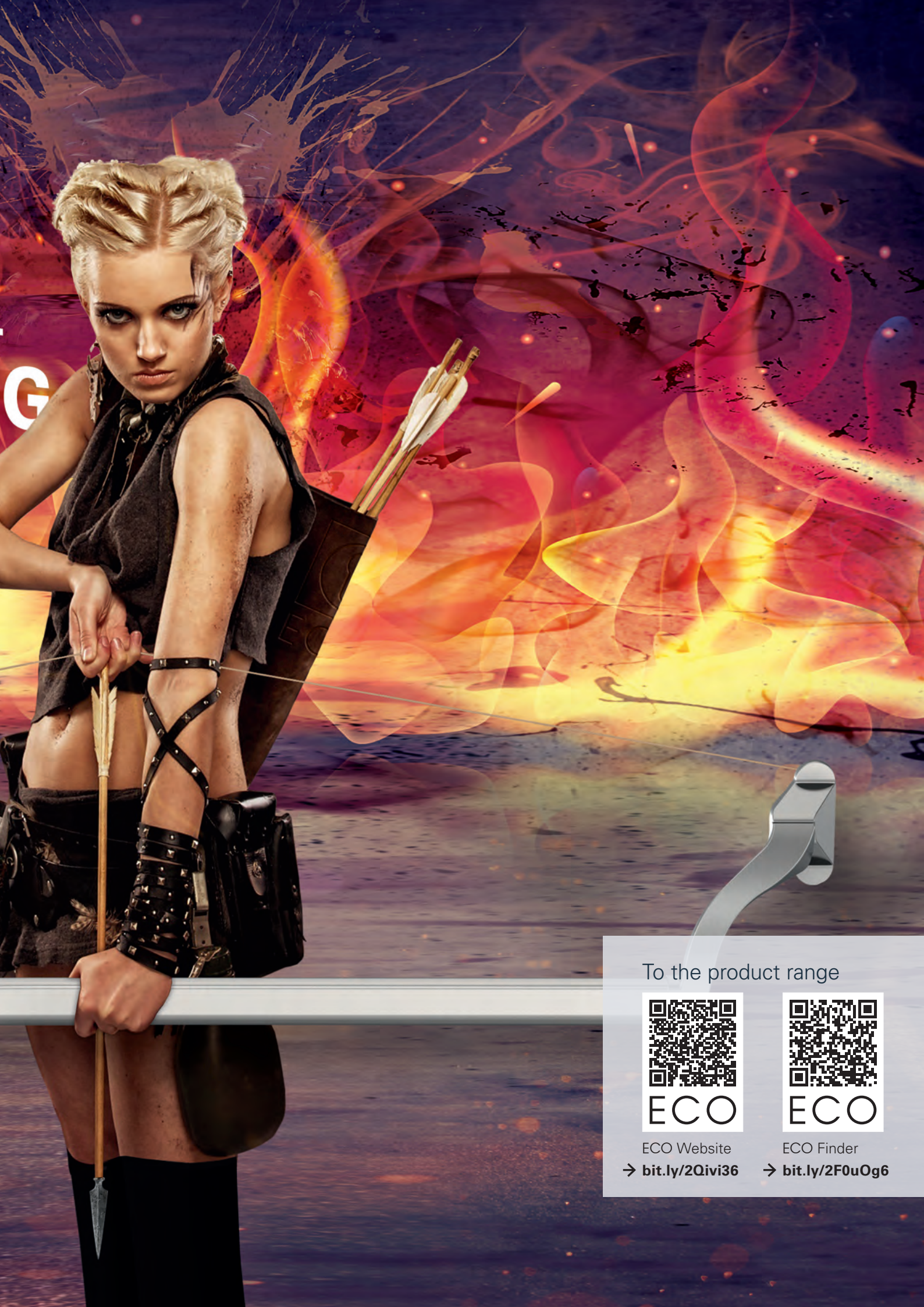

G



To the product range



ECO

ECO Website
→ bit.ly/2Qivi36



ECO

ECO Finder
→ bit.ly/2F0uOg6

PANIC BAR HANDLE SYSTEMS ECO **GUARDIAN**



Panic bar handle systems ■ Touchbar

Types of doors



Material

ER

Tests / standards

F **CE** **EN 1125**¹⁾



Guardian EPN 2000 II
Stainless steel

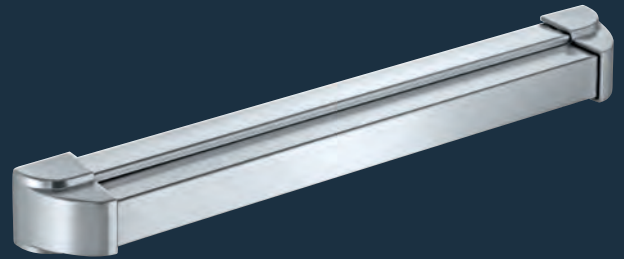

Guardian EPN 2000 II
Coated aluminium

Types of doors



Material

ER **AI**

Tests / standards

F **CE** **EN 1125**¹⁾

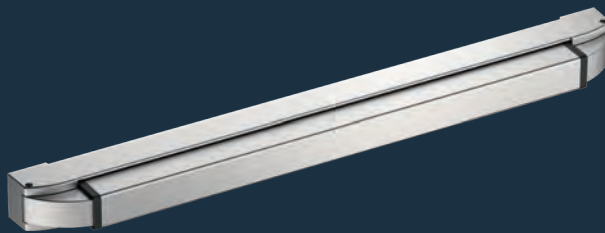

Guardian EPN 2000 III 2)

ER

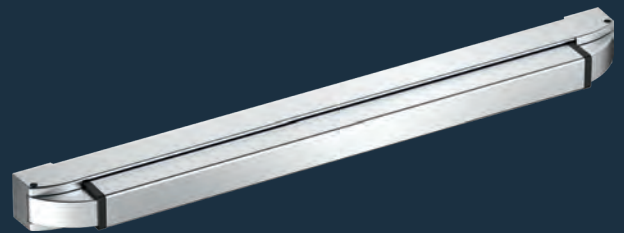

Guardian EPN 2000 III 2)

AI

ER = Stainless steel, AI = Aluminium

1) with approved exit device systems 2) available from the end of 2019



COUNTER FITTINGS



Guardian EPN 2000 II set
Round rose



Guardian EPN 2000 II set
Oval rose



Guardian EPN 2000 II set
Short plate

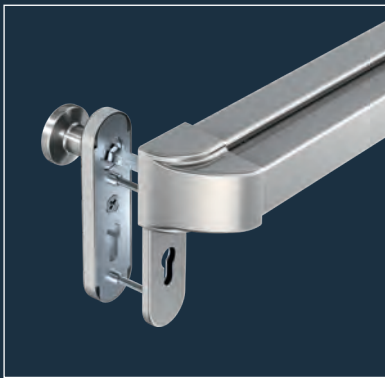

Guardian EPN 2000 II set
Si-short plate



Guardian EPN 2000 II set
Si-long plate



Guardian EPN 2000 II set
Si-tubular frame door

PANIC BAR HANDLE SYSTEMS

ECO **GUARDIAN**

Panic bar handle systems ■ Pushbar

Types of doors



Tests / standards



Guardian EPN 900 IV

ER



Guardian EPN 900 IV

AI



Guardian EPN 900 IV

Coated black / red

AI

Types of doors



Tests / standards



Guardian EPN 950

ER



Guardian EPN 950

AI

ER = Stainless steel, AI = Aluminium

1) with approved exit device systems



COUNTER FITTINGS



Guardian EPN 900 IV set
Oval rose



Guardian EPN 900 IV set
Short plate



Guardian EPN 900 IV set
Si-short plate



Guardian EPN 900 IV set
Si-long plate



Guardian EPN 900 IV set
Si-tubular frame door

PANIC LOCKS

FOR SINGLE-LEAF SOLID LEAF DOORS

Types of doors



Tests / standards



- GBS 82**
- PAF E D
 - DIN left / right useable mortise lock



- GBS 90 AVP**
- PAF E
 - Electronically blocking mortise lock



- GBS 198**
- Additional lock for three-latch closure



- GBS 91 AVP**
- PAF E
 - Self-locking mortise panic lock



- GBS 92**
- PAF E D C B
 - Standard mortise panic lock



- GBS 190**
- PAF E D C B
 - Main lock for three-latch closure



- GBS 130**
- PAF E D C B
 - Standard mortise panic lock with top locking



- GBS 199**
- Additional lock for higher positioned handle (kindergarten)



- GBS 198**
- Additional lock for three-latch closure

Multi-latch lock



PANIC LOCKS

FOR DOUBLE-LEAF SOLID LEAF DOORS

Types of doors



Tests / standards



GBS 83

- PAF E D
- DIN left / right useable mortise lock



GBS 84

- DIN left / right useable counter lock



GBS 93

- PAF E D C B
- Standard mortise panic lock



GBS 94

- Standard lock keep
- Top locking available as an option



GBS 94 RSK

- Integrated bolt switch contact
- Top locking available as an option



GBS 152 ETÖ

- Integrated E-opener
- Top locking available as an option

PANIC LOCKS

FOR SINGLE-LEAF PROFILE FRAME DOORS

Types of doors



Tests / standards



GBS 96

- PAF E D B
- Tubular frame panic lock
- Top locking available as an option



GBS 96 AVP

- PAF E D B
- Self-locking tubular frame panic lock
- Top locking available as an option



PANIC LOCKS

FOR DOUBLE-LEAF PROFILE FRAME DOORS

Types of doors



Tests / standards



GBS 97

- PAF E D B
- Tubular frame panic lock
- Top locking available as an option



GBS 97 AVP

- PAF E D B
- Self-locking tubular frame panic lock
- Top locking available as an option



GBS 98

- PAF E D B
- Tubular frame lock keep
- Top locking available as an option



GBS 98 ETÖ

- Tubular frame-lock keep with integrated E-opener
- Top locking available as an option



GBS 99M

- Motor-driven lock keep



GBS 99

- Mechanical lock keep for motor module

MORTISE LOCKS FOR SOLID LEAF DOORS

Types of doors



Tests / standards

EN 12 209



- GBS 12
- Object lock
 - Class 3



- GBS 15
- Object lock
 - Class 4



- GBS 31
- DIN left / right useable object lock
 - Class 4



- GBS 39
- Room door lock with Swiss dimensions
 - Class 3



- GBS 108
- Bolt lock
 - Class 4

DUAL LOCKING



- Dual locking system 1
- with a locking point at the top



- Dual locking system 2
- with a locking point at the top and bottom



FIRE PROTECTION MORTISE LOCKS

Types of doors



Tests / standards



- GBS 81**
- Mortise lock for fire protection doors



- GBS 94F**
- Drive dead bolt lock for fire protection doors



- GBS 109**
- Catch mortise lock for fire protection barriers



- GBS 140**
- Mortise lock for fire protection doors with device for additional catch upwards



- GBS 180**
- Mortise lock with 2 cylinder devices for fire protection doors



- GBS 187**
- Main lock for multi-point locking



- GBS 188S**
- Hook bolt as additional lock

PANIC LOCK FUNCTIONS

A panic lock works according to a defined principle: If the lever handle or panic bar on the inside is operated, the lock must open promptly under a defined application of force. In this case, not only the latch

is drawn back, but also the locked bolt if necessary. This basic function can be refined and varied using ECO technology.

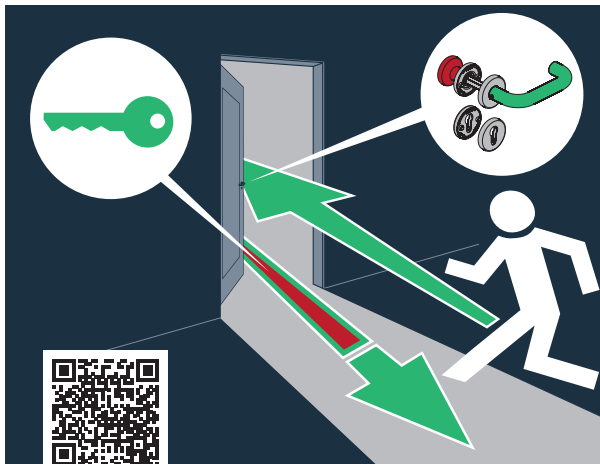

ECO © Video illustrating panic function E
bit.ly/2F3lt8q

Knob-lever function Panic function E

Panic function E is designed for buildings with access for a defined group of people. There is a blind plate or knob fitted on the outside, the door can only be opened by key. Classic panic function via the lever handle on the inside.

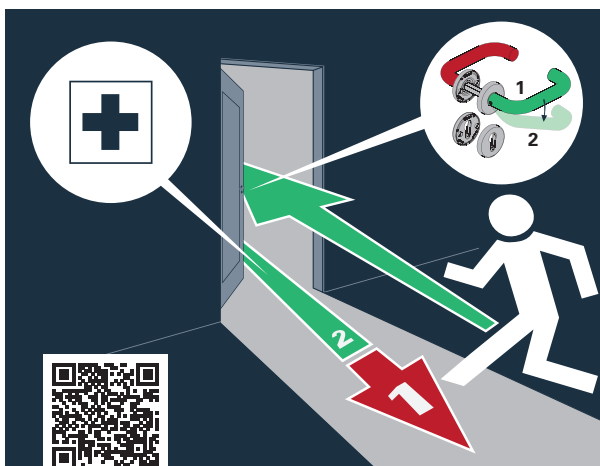

ECO © Video illustrating panic function D
bit.ly/2GR5jRa

Fire brigade function Panic function D

Panic function D is designed for pure escape doors which are not otherwise used: Following a classic panic operation from the inside the door is not only opened, the outer lever handle is engaged as well. In this setting, the door is no longer an obstacle for entry to nor escape from the building. The original function can be restored by a key. Engagement takes place mechanically through a two-part follower.

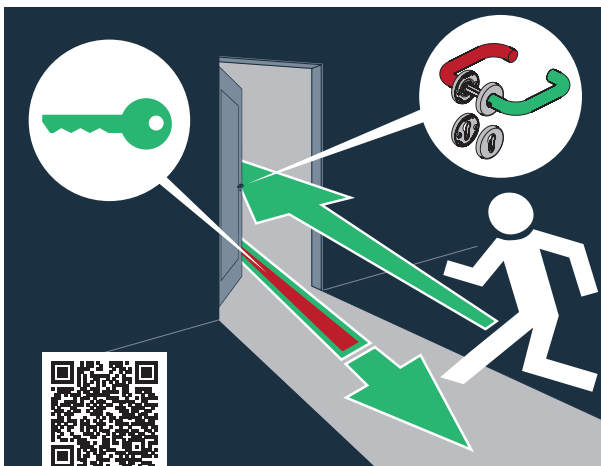

ECO

© Video illustrating panic function C
<http://bit.ly/2Ssy9IO>

Forced closure function Panic function C

Panic function C with a lever handle on both sides is designed for buildings accessible to the general public: Whereas the lever handle on the inside has a classic panic function, the lever handle on the outside is usually disengaged (idle function) and can only be disengaged and engaged through a key position (opening position) (forced closing). However, the key can only be removed when the idle function has been restored.

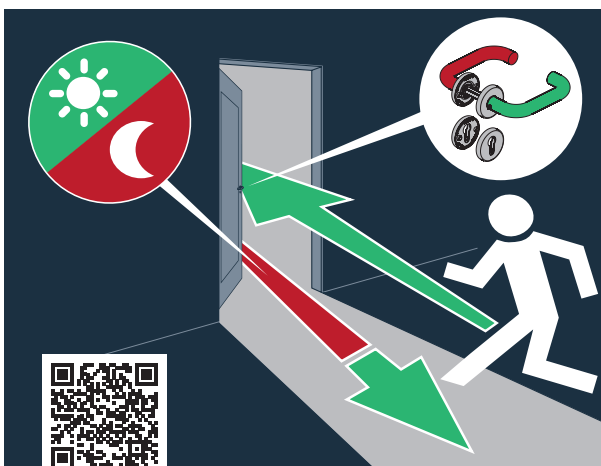

ECO

© Video illustrating panic function B
bit.ly/2F0vYlu

Switchover function Panic function B

Panic function B with a lever handle on both sides is designed for buildings accessible to the general public: Whereas the lever handle on the inside has a classic panic function, the lever handle on the outside can be disengaged or engaged mechanically as required. Engagement of the two lever handles takes place mechanically through a two-part follower.

NORMS DEPENDING ON BUILDING USE

The type of room and building use is decisive for selection of the right panic door combination. The European Norms **EN 1125** and **EN 179** define the equipment of panic doors and emergency exits. Emergency exit locks in accordance with **EN 179** are usually not used by the general public. It is assumed here that users of the building are familiar with the escape routes – so conventional panic lock technology

with handle or push plate is sufficient here. Panic locks with a horizontal activation bar in accordance with **EN 1125**, on the other hand, must be used in buildings frequented by the general public. Our panic systems in conformance with **EN 1125** ensure that persons who have panicked and are not acquainted with the functions of emergency exit doors can always get out of the building safely.

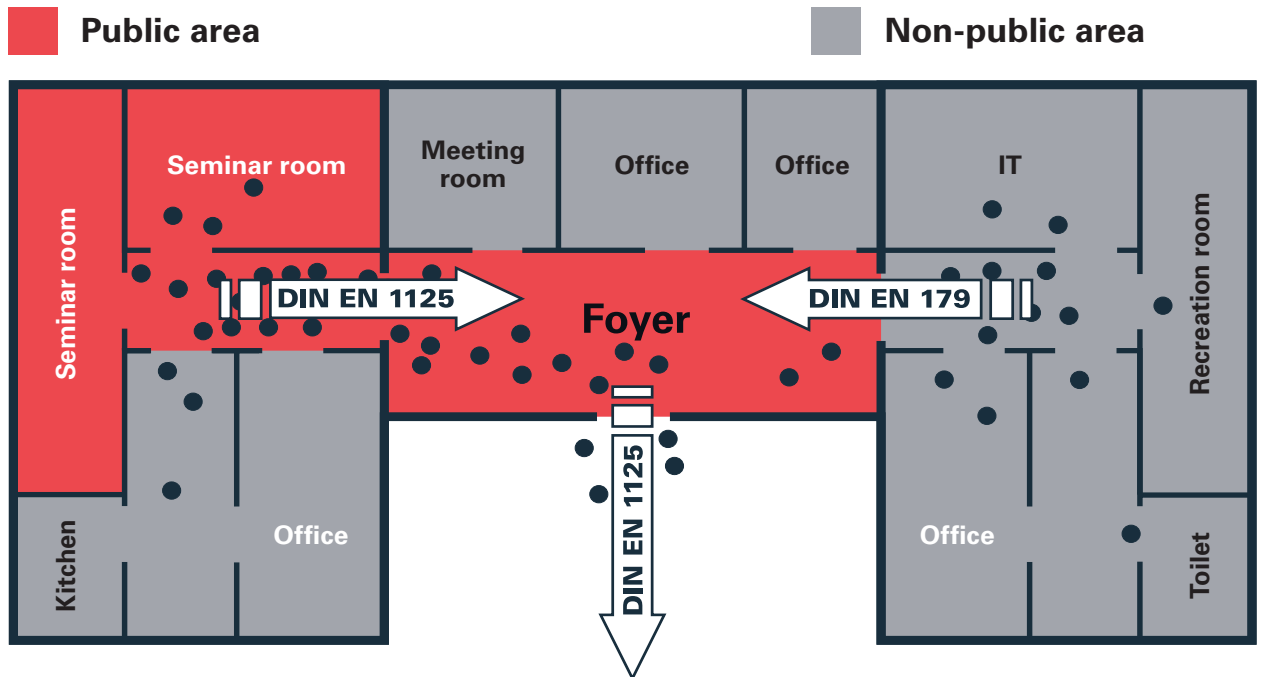



**Panic locks
with horizontal
activation bar**

EN 1125

Panic locks to **EN 1125** are used in public buildings where visitors are not acquainted with how the escape doors work but where they have to be able to use them in an emergency without instruction.

Panic locks activated mechanically by means of a horizontal handle or push bar.

Areas of use:

- Hospitals and clinics
- Escape routes in schools and educational institutions
- Public administration buildings
- Stadiums, arenas and event locations
- Shopping centres

Users have no prior knowledge of how to open the escape door.

**Emergency exit locks
with door handle**

EN 179

Emergency exit locks in accordance with **EN 179** are used in buildings or building sections which are closed to the general public and wherever the general public can be excluded. Side entrances or doors in these buildings or building sections are only used by authorised persons.

Emergency exit locks are operated mechanically via a lever handle or a push pad.

Areas of use:

- Private apartment blocks
- Classrooms in schools
- Non-public administration buildings or industrial companies
- Non-public areas of administration buildings
- Non-public areas of airports, banks, shopping centres

Users have prior knowledge of how to open the escape door.



SUPPORTING ROLLERS. HINGE TECHNOLOGY

■ SYSTEM TECHNOLOGY FOR THE DOOR

G

TECHNOLOGY



To the product range

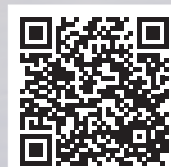

ECO

ECO Website

→ bit.ly/2s5kThF



ECO

ECO Finder

→ bit.ly/2F48zqm

OBJECT HINGES OBX 20

FOR REBATED NOTCH



Types of doors



Material



Tests / standards



OBX-20-1531/160

■ Class 14



OBX-20-1531/120

■ Class 14



OBX-20-1532/160 FD

■ Class 14



OBX-20-1532/120 FD

■ Class 14



OBX-20-1951/160

■ Class 14



OBX-20-1951/120

■ Class 14

ER = Stainless steel
FD = Leaf seal



OBJECT HINGES OBX-20

FOR UNREBATED NOTCH



Types of doors



Material



Tests / standards



OBX-20-2541/160
■ Class 14



OBX-20-2541/120
■ Class 14



OBX-20-2542/160
■ Class 14



OBX-20-2542/120
■ Class 14

OBJECT HINGES OBX-18 ECO HORIZON



Types of doors



Material



Tests / standards



Object hinges Horizon OBX-18 ■ for rebated notch



OBX-18-1531/160
■ Class 14



OBX-18-1531/120
■ Class 14



OBX-18-1532/160 FD
■ Class 14



OBX-18-1532/120 FD
■ Class 14

Object hinges Horizon OBX-18 ■ for unrebated notch



OBX-18-2541/160
■ Class 14



OBX-18-2541/120
■ Class 14



ACCESSORIES

Types of doors



OBX 20/18-Pick-up elements



OBX-3001-3D



OBX-3002-3D



OBX-3011-3D



OBX-3021-3D

OBX 20/18-Cover plate ■ for pick-up elements
(OBX-3001-3D / OBX-3002-3D)



OBX-3096

Rectangular / rectan-



OBX-3097

Rectangular/ round



OBX-3098

Round/ round



OBX-3099

Round / rectangular

OBX 20/18-Lifting lug



OBX-6012

Lifting lug

OBJECT HINGES OBN-14 ECO HORIZON

Types of doors



Material



Tests / standards



Object hinges Horizon OBN-14 ■ for unrebated notch

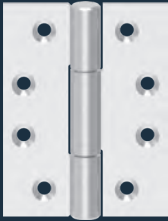

OBN-14-E-C

- Rectangular
- C-hole
- Class 14

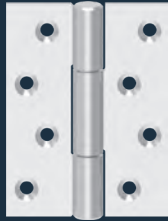

OBN-14-E-Z

- Rectangular
- Z-hole
- Class 14

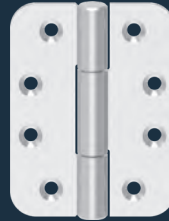

OBN-14-R-C

- Round
- C-hole
- Class 14

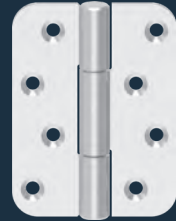

OBN-14-R-Z

- Round
- Z-hole
- Class 14

Hinge sizes OBN-14

in mm	in inches	in mm	in inches
101 x 76	4 x 3	114 x 101	4.5 x 4
101 x 89	4 x 3.5	127 x 76	5 x 3
101 x 101	4 x 4	127 x 101	5 x 4

ER = Stainless steel

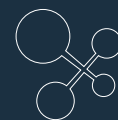

OBJECT HINGE OBN 20

FOR UNREBATED NOTCH

Types of doors



Material



Tests / standards



OBN-20-4141/160-R

- Round
- Z-hole
- Class 14

LIFTING LUG AND SECURITY HINGES

Types of doors



Material



Tests / standards



RC-A

- Hinge with RC-A hole



RC-B

- RC-A ▪ Hinge with RC-B hole

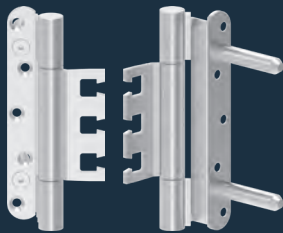

TZ

- Hinge with lifting lug

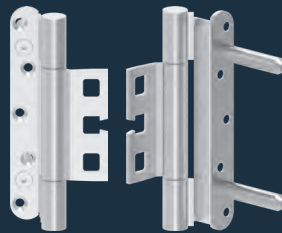

TZ RC-A

- Hinge with lifting lug
▪ and RC-A hole

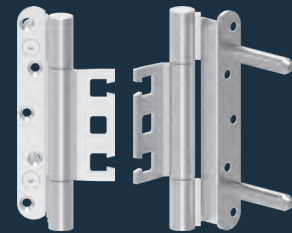

TZ RC-B

- Hinge with lifting lug
▪ and RC-B hole

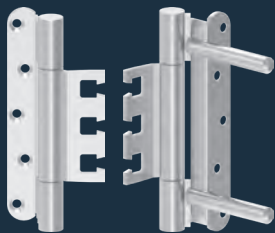

Si

- Hinge with securing pins

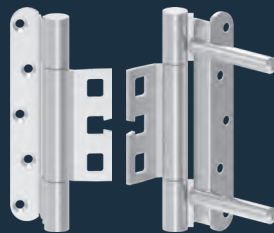

Si RC-A

- Hinge with securing pins
▪ and RC-A hole

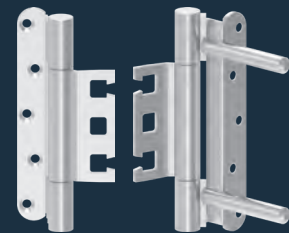

Si RC-B

- Hinge with securing pins
▪ and RC-B hole

Availabilities ¹⁾

Hinge	RC-A	RC-B	TZ	TZ RC-A	TZ RC-B	Si	Si RC-A	Si RC-B
OBX-18-1531/160	▪	▪	▪	▪	▪	▪	▪	▪
OBX-18-1532/160	▪	▪	▪	▪	▪	▪	▪	▪
OBX-18-2541/160	▪	▪	▪	▪	▪	▪	▪	▪

ER = Stainless steel

RC = Resistance class, TZ = Lifting lug, Si = Security hinge

¹⁾ In 2019



SPRING HINGES FOR STEEL DOORS

Types of doors



Material



Tests / standards



Genius LHA 3 mm

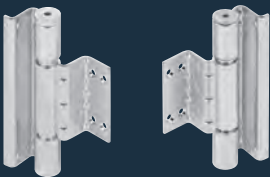

ECO Genius LHA

- Spring hinge /
KO hinge set 3 mm
- Class 12



ECO Genius LHA

- Spring hinge 3 mm



ECO Genius LHA

- KO hinge 3 mm
- Class 12

Standard set 3 mm

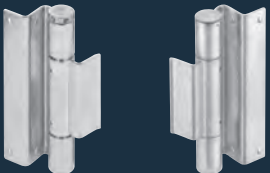

ECO Standard set

- Spring hinge /
KO hinge set 3 mm
- Class 12



ECO Standard set

- Spring hinge 3 mm



ECO Standard set

- KO hinge 3 mm
- Class 12

Standard set 4 mm

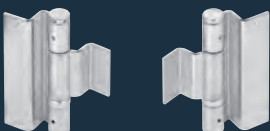

ECO Standard set

- Spring hinge /
KO hinge set 4 mm
- Class 13



ECO Standard set

- Spring hinge 4 mm



ECO Standard set

- KO hinge 4 mm
- Class 13

PERFORMANCE WEIGHTS AND LOADS

Door hinges are highly stressed construction elements: they not only have to bear the weight of the door itself, but much higher loads as well, depending on where they are used. Frequent door opening, slamming and unusual treatment of doors as in barracks or schools can make conventional hinges reach their load limit if they are simply designed to cope with the door weight.

ECO **Horizon** hinges have a closed hinge roller which prevents the roller bending open. No compromises have been made with the material thickness of the hinges either: the hinge plates of the ECO **Horizon** hinges can bear loads of up to 300 kg per hinge.

Maximum door weight of ECO Horizon object hinges				
Stop	Max. door weight: 300 kg	Max. door weight: 200 kg	Max. door weight: 160 kg	Max. door weight: 120 kg
rebated notch	OBX-20-1531/160	OBX-20-1531/120	OBX-20-1951/120	
	OBX-20-1532/160 FD	OBX-20-1532/120	OBX-18-1532/160	
		OBX-20-1951/160		OBX-18-1531/120
		OBX-18-1531/160		
unrebated notch	OBX-20-2541/160	OBX-20-2541/120		OBX-18-2541/120
	OBX-20-2542/160	OBX-20-2542/120		
	OBN-20-4141/160	OBX-18-2541/160		
		OBN-18-4141/160		
			OBN-14-E-C	
			OBN-14-E-Z	
			OBN-14-R-C	
		OBN-14-R-Z		

The values given were established under 100 % testing laboratory conditions on 2m high and 1 m wide doors as per EN 1935. Please remember this when selecting the object hinge or contact us for further details.

Assuming proper installation of the door, the material strength of the construction element to be attached and a frictional connection with the masonry: ECO **Horizon** hinges should be selected and used according to the above table with sufficient load and safety reserves for special areas of use as well. When ECO Schulte systems are used, a third hinge is only required under really difficult conditions. A third hinge that is attached in the top third of the door frame can increase the load-bearing capacity of the hinges by around one third. The data in the table refer to a door leaf size of 2 x 1 m, the use of two hinges and professional installation.

The numerous individual selection criteria such as areas of use, frequency of door passage etc. cannot be taken into account when determining the values. For this reason we recommend including safety reserves in the calculation and the selection of corresponding hinges to protect individuals.

We will be happy to help if you have any queries.



PREMIUM BALL BEARINGS

The quality of a hinge is determined to a great extent by the quality of the bearing. That is why ECO Schulte has developed its own bearing technology for its object hinges (patent: DE 103 61 548.2). The bearing is characteristic: the roller is guided top and bottom on a steel ball in two high-strength plastic cases. This specific bearing is wear-free, maintenance-free and clearance-free and guarantees smooth running of the door. The double bearing controls axial and radial forces effectively and permanently. In a series of practical tests, this bearing technology was successfully tested by an independent institute for more than one million closing actions. That more than guarantees lifelong, secure fastening.

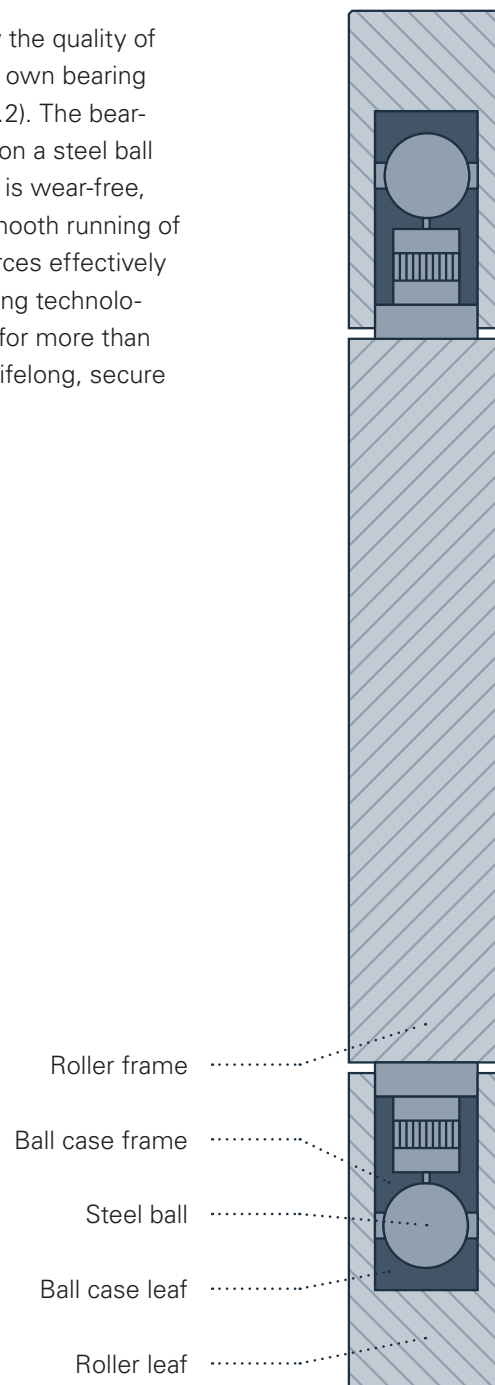

ADVANTAGES ECO HORIZON





Performance criteria

- **Hinge class:** 14
- **Use class:** 4, very heavy
- **Long-term operability:** 200,000 cycles

USPs

- Clearance-free, patented and maintenance-free premium ball bearing
- Automated, innovative production technology with minimum tolerances and gap dimensions
- No lubricants used
- Easy to clean thanks to closed hinge roller - especially suitable for hygiene-critical areas
- Opening resistance significantly under the test norm required
- Guarantee: Entire service life

Burglar resistance

- No pin securing necessary, since there is no full floating axle
- Not possible to lever out the closed hinge roller (made of solid material)

Design

- Seamless hinge design without cover head top/bottom thanks to closed hinge roller
- Attractive finish pattern thanks to longitudinal polishing
- Automated, innovative production technology with minimum tolerances thanks to laser welding technology





ITM:

INTELLIGEN
DOOR MAN

T AGEMENT

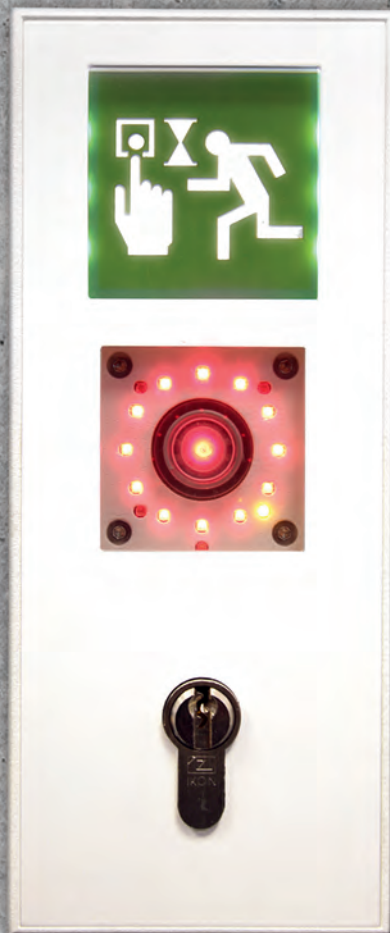

To the product range

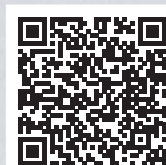

ECO

ECO Website

→ bit.ly/2s2Xiyj



ECO

ECO Finder

→ bit.ly/2s6aCBY

ELECTROMOTIVE SWING DOOR DRIVE ECO ETS

Single-leaf swing door drives ■ for standard and external doors

Types of doors



Tests / standards

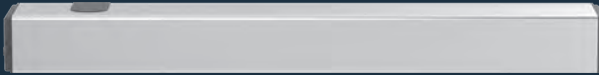

ETS 42
(EN 2 – 4)



ETS 73
(EN 3 – 7)

Single-leaf swing door drives ■ for fire and smoke protection

Types of doors



Tests / standards

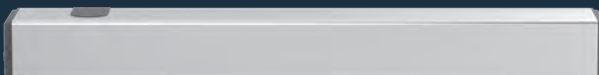

ETS 42-R¹⁾
(EN 2 – 4)

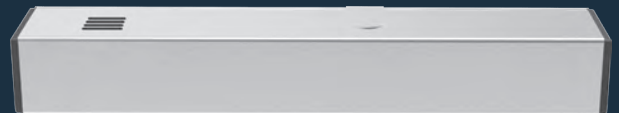

ETS 64-R
(EN 3 – 6)

Single-leaf swing door system for fire and smoke protection doors (and Invers)

- ETS 64-R
- ETS 64-R (GSD)
- ETS 64-R IRM
- ETS 64-R IRM (GSD)

Slide rail for ETS

- GS-ETS 620-ÖB²⁾
- GS-ETS 830³⁾

Normal arm for ETS

- NG-ETS 250⁴⁾
- NG-ETS 400⁵⁾

R = Fire protection, GSD = Version with slide rail pushing (BG transom installation), GSZ = Version slide rail pulling (BS-normal installation), IRM = Integrated smoke detector, NG = Version with normal arm pushing (BG transom installation), SRI = Integrated closing sequence control

1) From 2020 **2)** Type of installation GSZ or GSD (up to 30 mm lintel depth / fire protection door) **3)** Type of installation SZ, GSD or leaf installation (up to 200 mm lintel depth / no fire protection door) **4)** For lintel up to 250 mm (fire protection door) **5)** For lintel up to 400 mm (not fire protection door)



Double-leaf drives ■ for fire and smoke protection

Types of doors



Tests / standards



ETS 64-R IRM-SRI

Double-leaf drives for fire protection doors (complete sets)

- ETS 64-R IRM-SRI (NG)**
- ETS 64-R IRM-SRI (GSD)**
- ETS 64-R IRM-SRI (GSZ)**

Double-leaf for standard and external doors

- ETS 42-2**
- ETS 73-2**

ESCAPE ROUTE & SMOKE EXTRACTION OPENER **FTA ECO-VENT** TS-62

Types of doors



Tests / standards



Contains:

- ECO **Newton** TS-62
- Flap drive K-600
- Assembly angle



AUTOMATIC / MOTOR-DRIVEN MULTIPLE LOCKING

Types of doors



Tests / standards



833 / 833P



834 / 834P

P = Panic version

INTELLIGENT DOOR MANAGEMENT

ECO ITM

Types of doors



Tests / standards

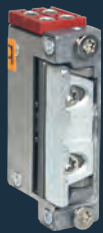

Standard door opener



Fire protection door opener

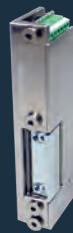

Escape route door opener



FTI
EN 13637



FT3 Basic
EN 13637



Escape route terminal plus
EN 13637



Emergency button with icon

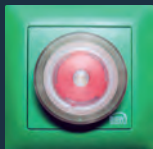

Emergency button

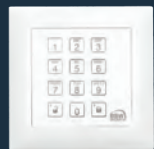

Code keypad

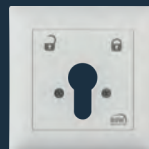

Key switch



Fingerprint



Transducer and switch box

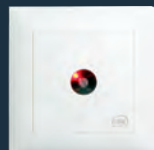

Access system plus

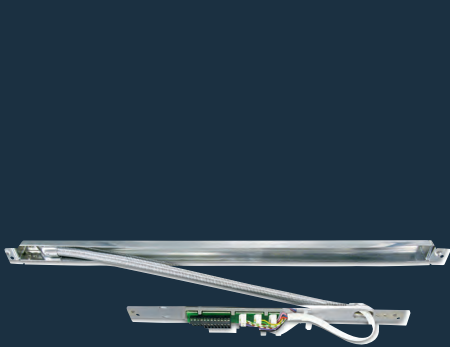

Cable transition

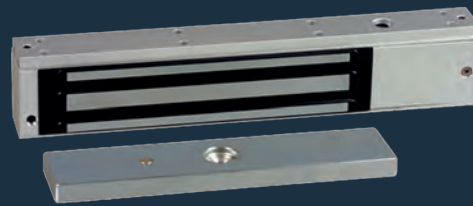

Large-surface retaining magnet



Power supplies

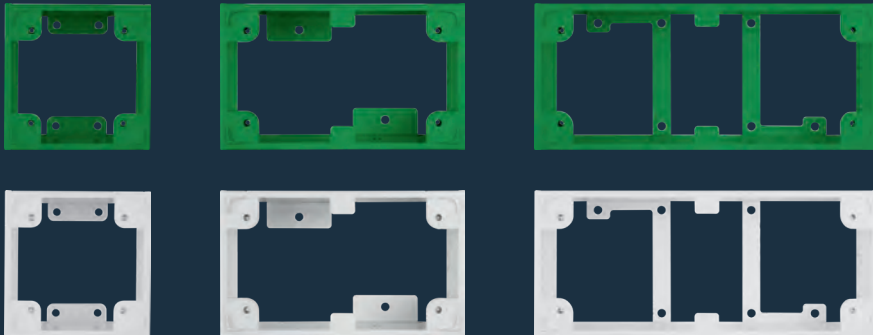

Housing



A WORLD OF DOORS

The urban world from above; a world full of intelligently managed doors. Hardware, mechatronics and software are combined in the building and fire alarm technology. They grant access or prevent it. They open doors and close them again. They create escape routes and secure fire prevention areas. They identify users through their fingerprints or card systems, they document access and report any unauthorised activity. They protect our belongings – yet make them safely accessible to authorised people. And finally they save lives. **We call this intelligent door management.**

Underground parking escape door with access control in the administrative building of a bank

Escape and fire barrier doors on the floors of a luxury hotel

Emergency exit to stairway in a shopping mall

Emergency exit to the fire escape staircase in a students' hostel





Electrically operated emergency exit
in access to a penthouse roof terrace

Electrically operated emergency exit
in an old people's home with short-
term care

Section door with multiple lock points:
access to an administration floor

Double-leaf escape doors at an
indoor stadium with VIP lounges

Floor with electronic access control:
the showroom of a designer furniture company

Access control and escape doors:
outpatient day clinic

Garage staircase:
escape door in residential
building



FROM PLANNING TO THE COMPLETE SOLUTION

Two partners who ideally complement each other. ECO **Schulte** from Menden in North-Rhine Westphalia and **BSW SECURITY AG** from Switzerland. Their expertise in clearly defined and they complement each other perfectly. ECO Schulte is the specialist for the hardware on the door. From handles and hinges, fittings, door closers and lock technology; the range works for all kinds of doors – profile doors, steel doors and wooden doors. BSW SECURITY then integrates the ECO Schulte hardware into the building process control and fire detection technology. The objective of this **partnership of specialists** is to integrate all the mechatronics and electronics to do with the doors – with open interfaces to the building process control system.

DESIGN CONTRACT COMPLEX DOOR MANAGEMENT



Mechanics



Engineering

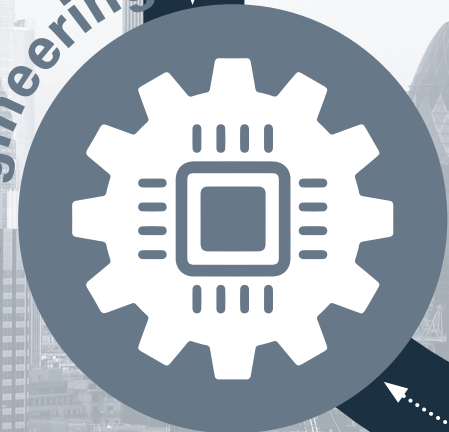



Intelligent Door Management makes high demands on both the mechanical and the electronic components. The planning for all parties involved in the construction process is just as demanding – no matter whether this is on the part of the contractors, the architects, the specialist planners for technical building equipment or the companies that carry out the work. As a system specialist for doors, this cooperation, based in Menden, is able to put together a complete, turnkey offer for any demanding door facilities. This can take account of all aspects including security, access control, escape routes and fire

protection. ECO Schulte sees itself here as a system integrator – even for solutions involving different manufacturers. Any change of use of existing facilities are also possible here if, for example, existing components can be taken over.

Planners and contractors can expect a complete package of hardware, software and electronics as well as planning and service from ECO Schulte. And of course the guarantee that the system, as well as each individual component, conforms with the current standards.



ELECTROMOTIVE SWING DOOR DRIVE ECO **ETS**

Harmonious door movement:
motor-driven opening and controlled closing.

The new **ETS** from ECO is a powerful, low-noise, electromotive drive for heavy internal and external doors up to 400 kg (250 kg for fire protection / smoke protection doors). Equally suitable for new facilities and modernisations.

Versions and functions:

- Slide rails pushing (BG) and pulling (BS)
- 1- and 2-leaf systems with continuous cover
- Integrated, concealed closing sequence control for fire/smoke protection doors (in the universal cladding)
- Integrated, concealed smoke detector
- Easy operation with illuminated program selection keys in the side cover (automatic, always on, manual, exit and night)
- Plug + Play, set-up of functions with LCD display
- Adjustable starting force and closing force amplification
- Adjustable start delay (motorised lock, closing sequence)
- Connectable wind load compensation, max. wind speed 80 km/h (320 Pa)
- Push & Go function can be adjusted under servo support





ETS

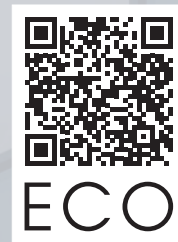

ECO Website

→ bit.ly/2GMFC42

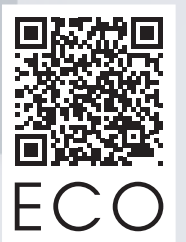

ECO Finder

→ bit.ly/2s6aCBY



THE SYSTEM IN FOCUS ECO SETS

■ SYSTEM TECHNOLOGY FOR THE DOOR

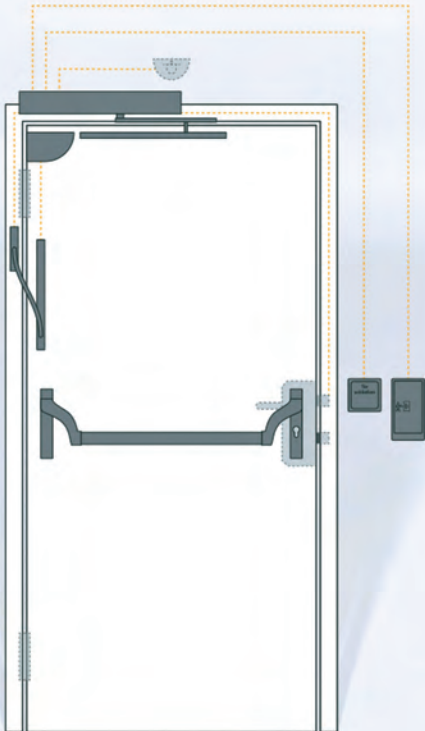

Door management



ECO

ECO configurator
→ bit.ly/2CJVLmG

THE HOLISTIC APPROACH

ECO SET SOLUTIONS

Sometimes, there is a simple solution to complex tasks: On the next few pages we have put together some pre-assembled set solutions for you which cover typical tasks in the planning, design and networking of a door.

Put in a nutshell for you:

- Planning schematic
- Product list
- Norm overview
- Recommended areas of use
- More detailed online information

WE THINK FROM THE DOOR

We think for you, from your perspective – and this perspective is your next door. Because it makes a significant difference whether this is made of steel, wood or section, whether it has one or two leaves, is heavy or light and which function it is to perform. Your next door is our benchmark.



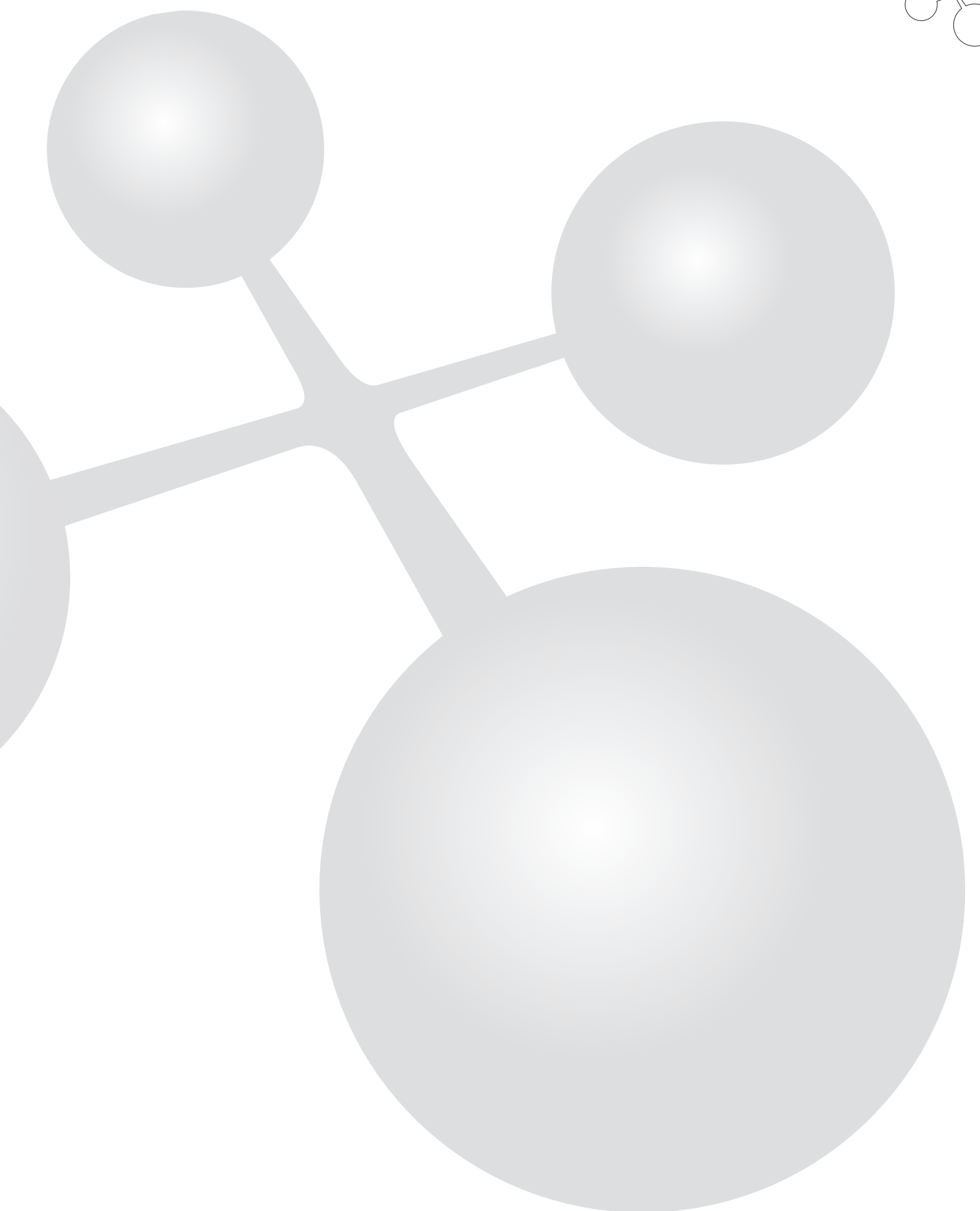
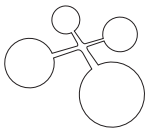

#01: SINGLE-LEAF STEEL DOOR

SET SOLUTION

ECONOMICAL

- Purely mechanical solution
- With fire and smoke protection function
- Available in various finishes
- Tested and approved technology

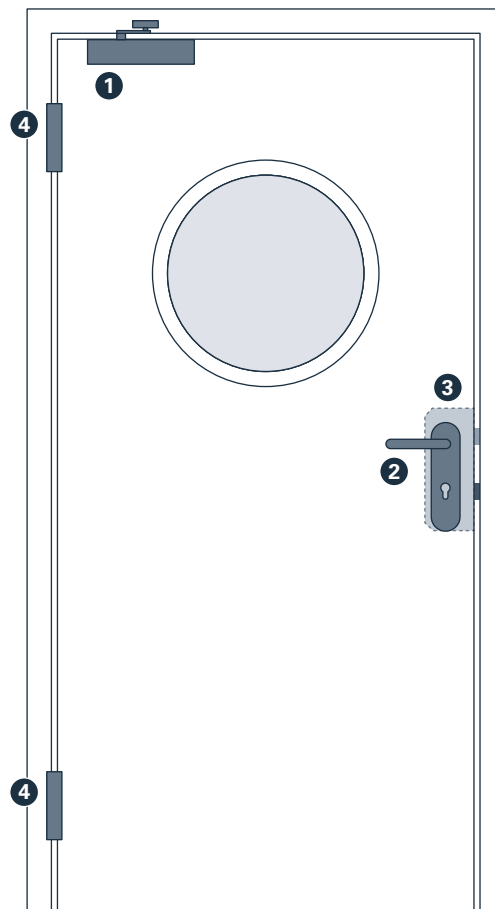

View pull side



① Door closer
TS-50 + ADP SGS

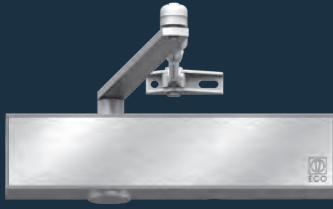

1x

② Fitting
**OGL short plate
D-110**



2x

③ PSVT
GBS 81



1x

④ Hinge
construction hinge



2x

PUBLIC

EDUCATION

HEALTHCARE

INDUSTRY

OFFICE

RESIDENTIAL

TRANSPORT

HOTEL

NORMS:

EN 16034, EN 1154,
EN 1906, EN 12209,
EN 1935, DIN 18273

ECO Configurator

Find out more
information here
or get in touch with
us directly:



→ bit.ly/2LNNtgz

#02: SINGLE STEEL DOOR

SET SOLUTION

HIGH-QUALITY

- Mechatronic solution
- With fire and smoke protection function
- With panic function
- Available in various finishes
- Multi-functional usability
- Tested and approved technology

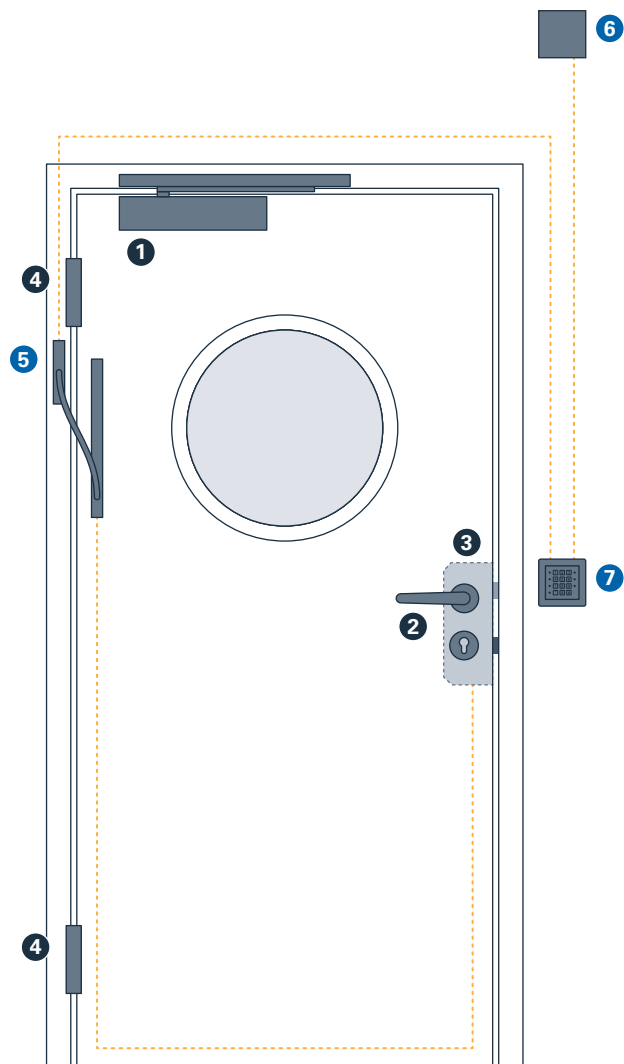

View pull side



① Door closer
TS-61 with GS-B + ADP 30 GS-B



1x

② Fitting
OKL Magis D-410



2x

③ PSVT
GBS 90 S0 02 and 06



1x

④ Hinge
construction hinge



2x

⑤ ITM
Cable connection



1x

⑥ ITM
Power supply



1x

⑦ ITM
Code keypad



1x

PUBLIC

EDUCATION

HEALTHCARE

INDUSTRY

OFFICE

RESIDENTIAL

TRANSPORT

HOTEL

NORMS:

EN 16034, EN 1154,
EN 1906, EN 12209,
EN 179, EN 1935,
DIN 18273

ECO Configurator

Find out more
information here
or get in touch with
us directly:

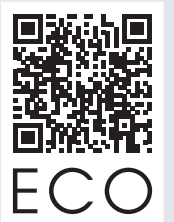

→ bit.ly/2RaFpg4

#03: SINGLE-LEAF STEEL DOOR

SET SOLUTION

ITM

- Mechatronic solution
- With fire and smoke protection function
- With panic function
- Available in various finishes
- Barrier-free solution
- Multi-functional usability
- Tested and approved technology

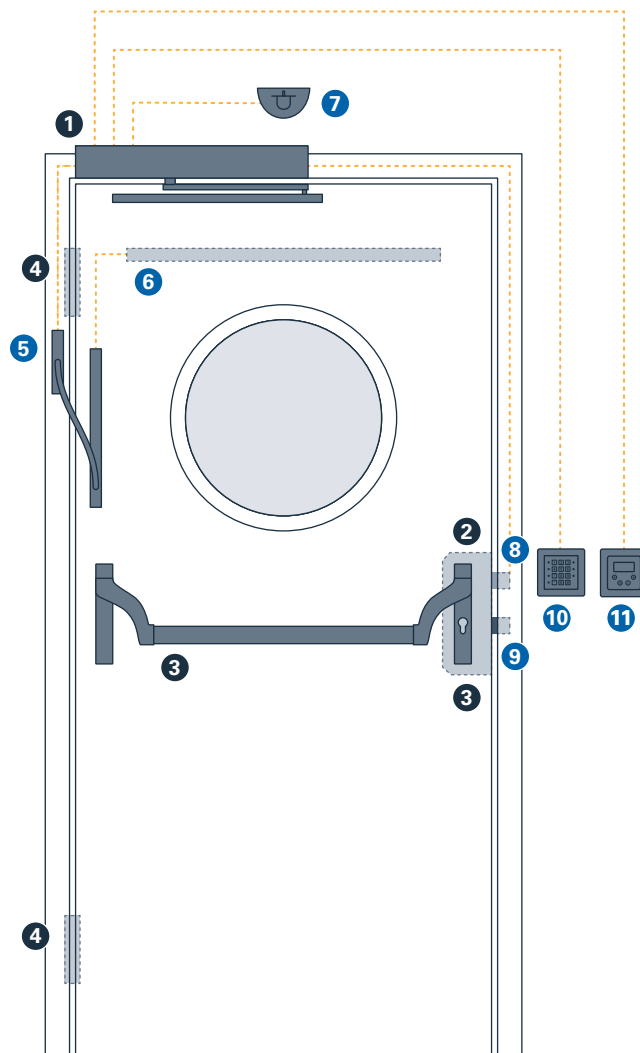

View pull side



① Door closer
ETS 64 R IRM with GS, pushing

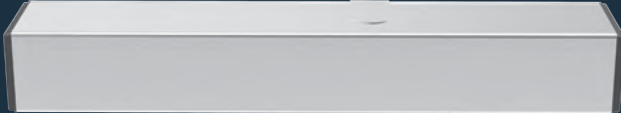

+Finger protection blind

1x

② Fitting
ES1 Short plate
K-130



1x

③ PSVT
EPN 900 IV + GBS 92



1x 1x

④ Hinge
construction hinge



2x

⑤ ITM
Cable connec-
1x

⑥ ITM
Sensor bars
4Safe Set III
1x

⑦ ITM
Radar
1x

⑧ ITM
Fire protection
E-opener
1x

⑨ ITM
Bolt switch contact
1x

⑩ ITM
Code batch keyboard
1x

⑪ ITM
Bedix
1x

- | | |
|--|---|
| <input checked="" type="checkbox"/> PUBLIC | <input checked="" type="checkbox"/> EDUCATION |
| <input checked="" type="checkbox"/> HEALTHCARE | <input type="checkbox"/> INDUSTRY |
| <input checked="" type="checkbox"/> OFFICE | <input type="checkbox"/> RESIDENTIAL |
| <input checked="" type="checkbox"/> TRANSPORT | <input checked="" type="checkbox"/> HOTEL |

NORMS:

EN 16034, EN 1154,
EN 12209, EN 1125,
EN 1935, EN 16005,
DIN 18263-4, DIN 18273

ECO Configurator

Find out more
information here
or get in touch with
us directly:

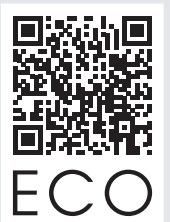

ECO

→ bit.ly/2s3uRQI

#04: DOUBLE-LEAF STEEL DOOR SET SOLUTION FULL PANIC MECHANICAL

- Mechanical solution
- With fire and smoke protection function
- With panic function
- Available in various finishes
- Tested and approved technology

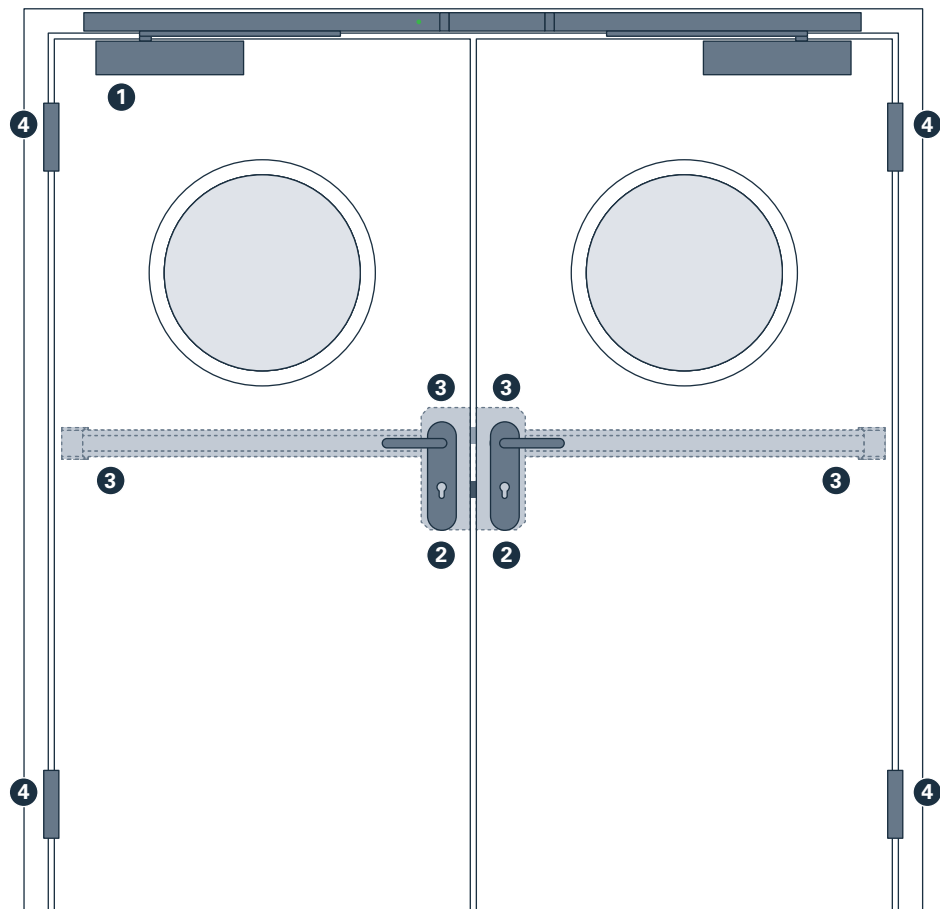

View pull side

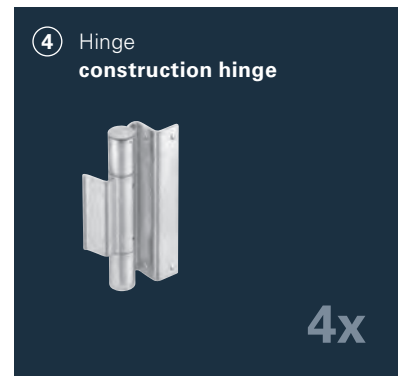
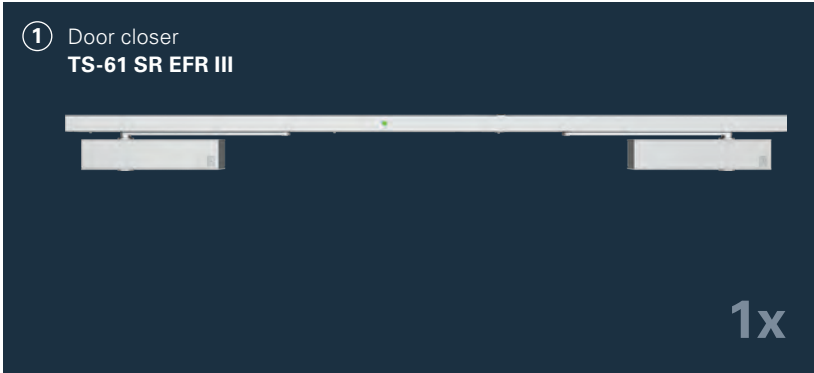

- | | |
|--|---|
| <input checked="" type="checkbox"/> PUBLIC | <input checked="" type="checkbox"/> EDUCATION |
| <input checked="" type="checkbox"/> HEALTHCARE | <input checked="" type="checkbox"/> INDUSTRY |
| <input type="checkbox"/> OFFICE | <input type="checkbox"/> RESIDENTIAL |
| <input checked="" type="checkbox"/> TRANSPORT | <input checked="" type="checkbox"/> HOTEL |

NORMS:

EN 16034, EN 1155,
EN 1158, EN 12209,
EN 1125, EN 1935,
DIN 18273

ECO Configurator

Find out more
information here
or get in touch with
us directly:

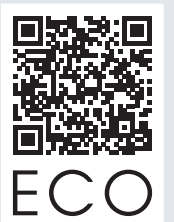

ECO

→ bit.ly/2s523Y2

#05: DOUBLE-LEAF STEEL DOOR SET SOLUTION ITM

- Mechatronic solution
- With fire and smoke protection function
- With panic function
- Available in various finishes
- Barrier-free solution
- Multi-functional usability
- Tested and approved technology

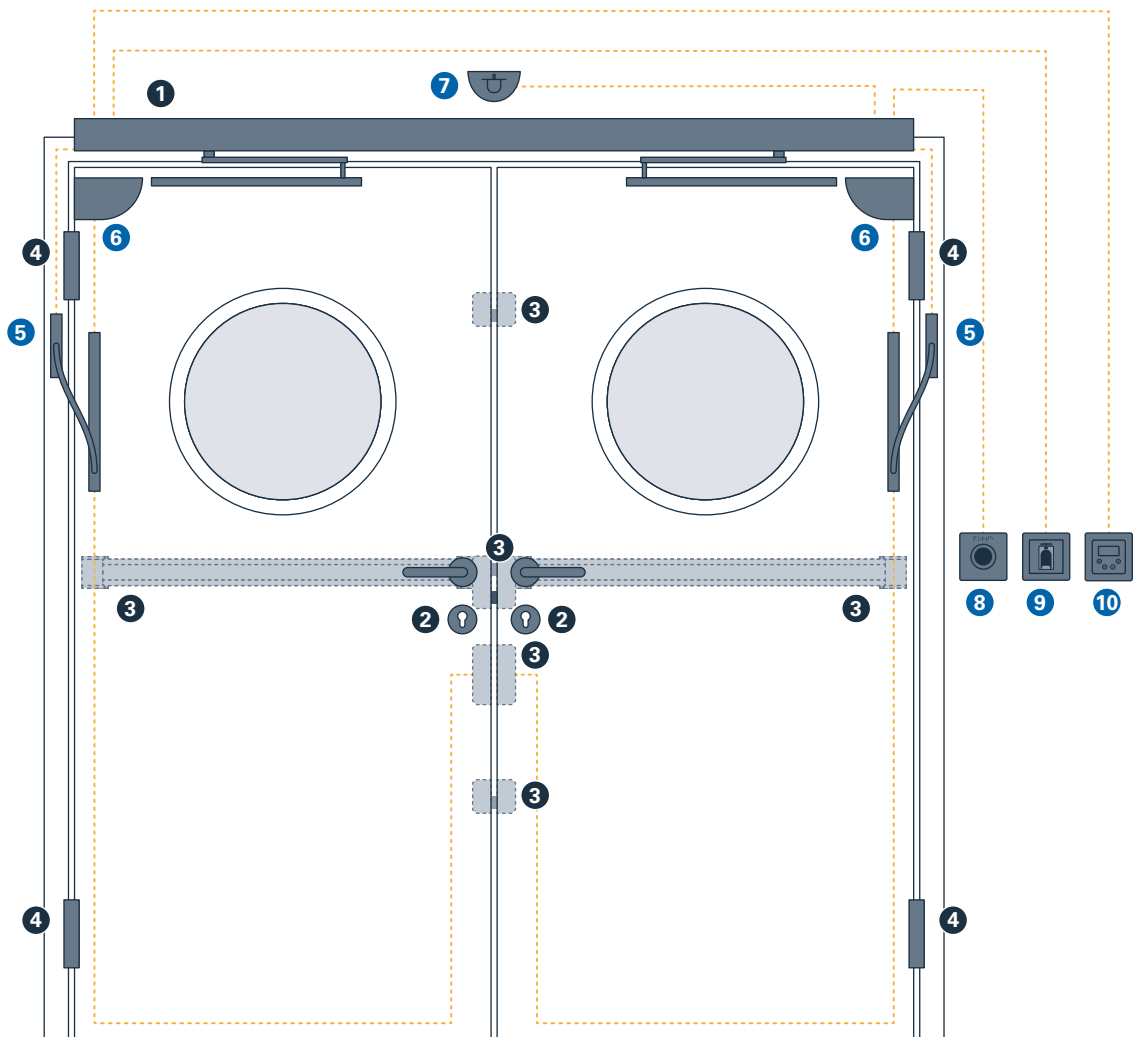

View pull side



① Door closer
ETS 64-IRM-SRI (GSZ)



1x

② Fitting
OKL Magis D-330



2x

③ PSVT
EPN 2000 II + ECO Autotronic 834P + ECO GBS 99M + GBS 99



2x 1x 1x 1x

④ Hinge
construction hinge



4x

⑤ ITM
Cable connection



2x

⑥ ITM
Flatscan



2x

⑦ ITM
Radar



1x

⑧ ITM
BFT



1x

⑨ ITM
ECO Fingerprint



1x

⑩ ITM
Bedix



1x

- | | |
|--|---|
| <input checked="" type="checkbox"/> PUBLIC | <input checked="" type="checkbox"/> EDUCATION |
| <input checked="" type="checkbox"/> HEALTHCARE | <input checked="" type="checkbox"/> INDUSTRY |
| <input type="checkbox"/> OFFICE | <input type="checkbox"/> RESIDENTIAL |
| <input checked="" type="checkbox"/> TRANSPORT | <input checked="" type="checkbox"/> HOTEL |

NORMS:

EN 16034, EN 14846,
EN 1125, EN 1935,
EN 16005, EN 18263-4,
DIN 18040, DIN 18273

ECO Configurator

Find out more information here or get in touch with us directly:

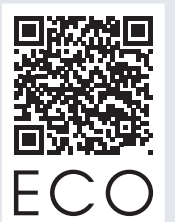

ECO

→ bit.ly/2LLDGb1

#06: SINGLE-LEAF WOODEN DOOR

SET SOLUTION

ECONOMICAL

- Purely mechanical solution
- With fire and smoke protection function
- Available in various finishes
- Tested and approved technology

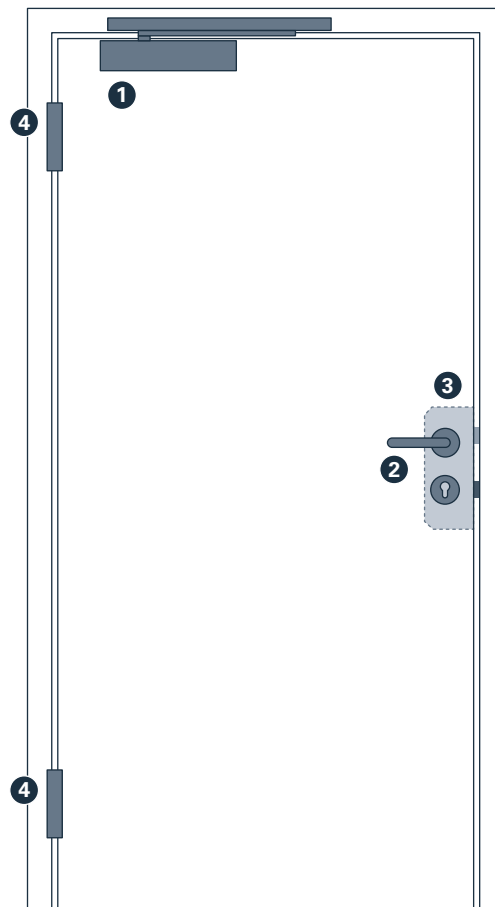

View pull side

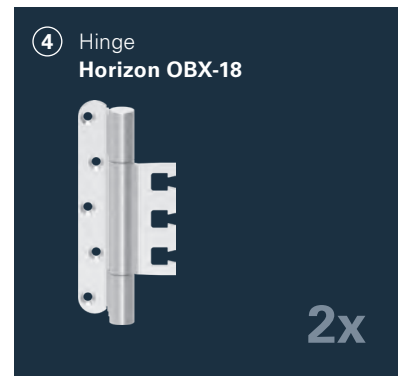
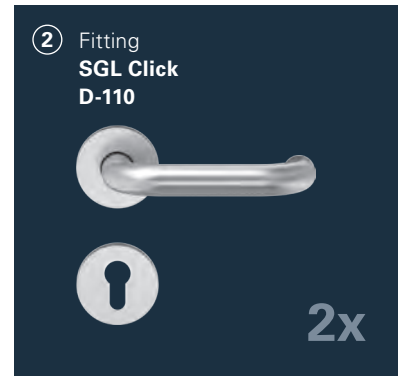

<input checked="" type="checkbox"/> PUBLIC	<input type="checkbox"/> EDUCATION
<input type="checkbox"/> HEALTHCARE	<input checked="" type="checkbox"/> INDUSTRY
<input checked="" type="checkbox"/> OFFICE	<input checked="" type="checkbox"/> RESIDENTIAL
<input checked="" type="checkbox"/> TRANSPORT	<input type="checkbox"/> HOTEL

NORMS:

EN 16034, EN 1154,
EN 1906, EN 12209,
EN 1935, DIN 18273

ECO Configurator

Find out more
information here
or get in touch with
us directly:



→ bit.ly/2R7Crc6

#07: SINGLE-LEAF WOODEN DOOR

SET SOLUTION

BURGLARY PROTECTION

- Purely mechanical solution
- With fire and smoke protection function
- With panic function
- Available in various finishes
- Tested and approved technology

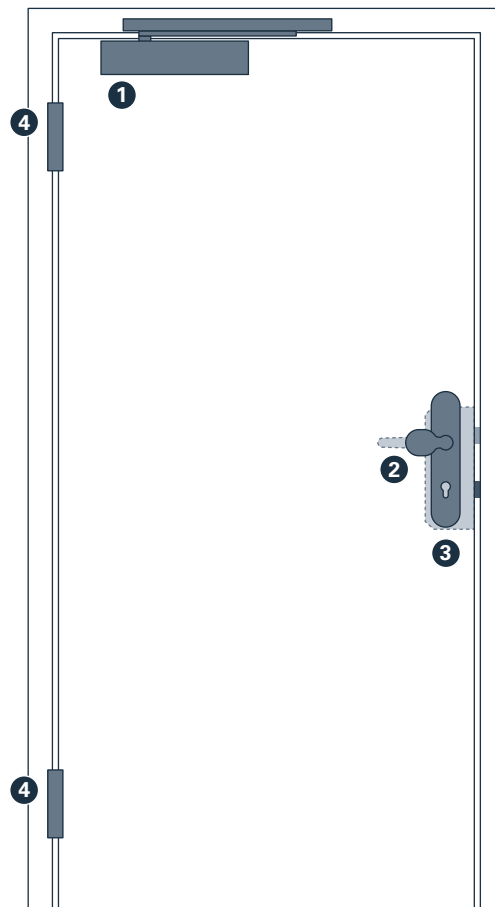

View pull side



① Door closer
TS-62



1x

② Fitting
**Combined protective fitting
G-160 / D-410**

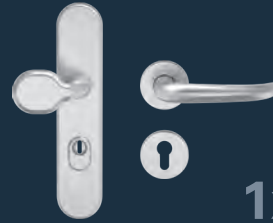

1x

③ PSVT
GBS-91 (self-locking)



1x

④ Hinge
Horizon OBX-18 (RC 3)



2x

<input type="checkbox"/> PUBLIC	<input type="checkbox"/> EDUCATION
<input type="checkbox"/> HEALTHCARE	<input type="checkbox"/> INDUSTRY
<input type="checkbox"/> OFFICE	<input checked="" type="checkbox"/> RESIDENTIAL
<input type="checkbox"/> TRANSPORT	<input type="checkbox"/> HOTEL

NORMS:

EN 16034, EN 1154,
EN 1906, EN 12209,
EN 179, EN 1935,
DIN 18040,
DIN Spec 1104,
DIN 18273

ECO Configurator

Find out more
information here
or get in touch with
us directly:



→ bit.ly/2ArVvXU

#08: SINGLE-LEAF WOODEN DOOR

SET SOLUTION

HIGH-GRADE

- Purely mechanical solution
- With fire and smoke protection function
- Available in various finishes
- Tested and approved technology

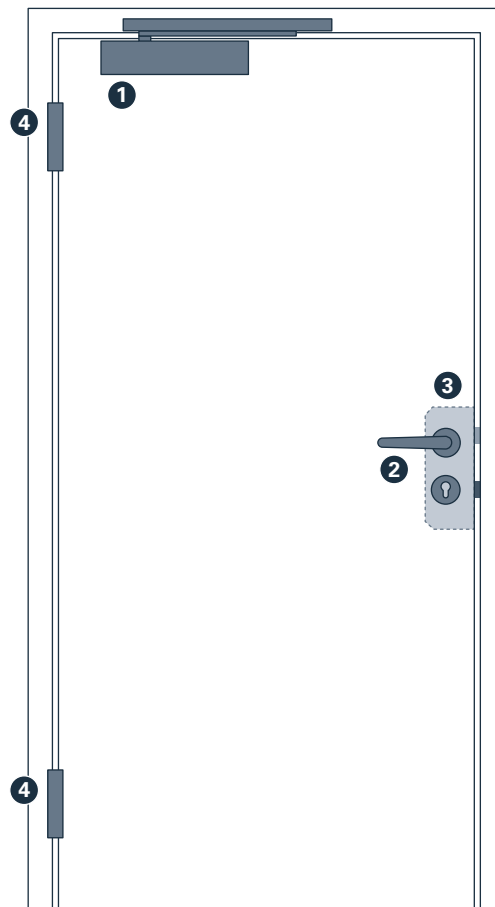

View pull side



① Door closer
TS-61 closing delay



1x

② Fitting
OKL Magis
D-410



2x

③ PSVT
GBS-15



1x

④ Hinge
Horizon OBX-18



2x

PUBLIC

EDUCATION

HEALTHCARE

INDUSTRY

OFFICE

RESIDENTIAL

TRANSPORT

HOTEL

NORMS:

EN 16034, EN 1154,
EN 1906, EN 12209,
EN 1935, DIN 18273

ECO Configurator

Find out more
information here
or get in touch with
us directly:



→ bit.ly/2R2Hc6w

#09: SINGLE-LEAF WOODEN DOOR SET SOLUTION PREMIUM

- Mechatronic solution
- With fire and smoke protection function
- With panic function
- Available in various finishes
- Barrier-free solution
- Multi-functional usability
- Tested and approved technology

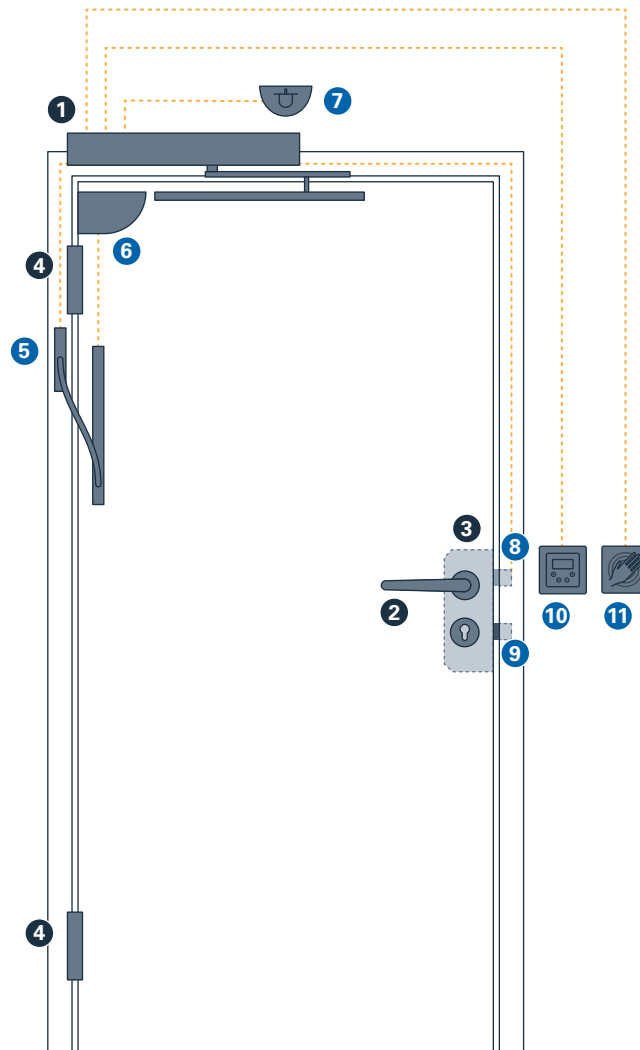

View pull side



① Door closer
ETS 42-Servo with GS 620 ÖB + axle pin 38

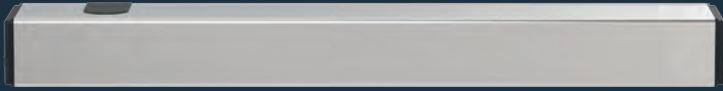

1x

② Fitting
OKL Magis
D-490



2x

③ PSVT
GBS-92



1x

④ Hinge
Horizon OBX-18



2x

⑤ ITM
Cable connection



1x

⑥ ITM
Flatscan



1x

⑦ ITM
Radar



1x

⑧ ITM
E-opener



1x

⑨ ITM
Bolt switch contact



1x

⑩ ITM
Bedix



1x

⑪ ITM
Magic Switch



1x

<input checked="" type="checkbox"/> PUBLIC	<input checked="" type="checkbox"/> EDUCATION
<input checked="" type="checkbox"/> HEALTHCARE	<input type="checkbox"/> INDUSTRY
<input type="checkbox"/> OFFICE	<input type="checkbox"/> RESIDENTIAL
<input type="checkbox"/> TRANSPORT	<input checked="" type="checkbox"/> HOTEL

NORMS:

EN 16034, EN 1154,
EN 12209, EN 179,
EN 1935, EN 16005,
DIN 18263-4, EN 18040,
DIN 18273

ECO Configurator

Find out more
information here
or get in touch with
us directly:



ECO

→ bit.ly/2TrASm2

#10: SINGLE-LEAF WOODEN DOOR SET SOLUTION ITM

- Mechatronic solution
- With fire and smoke protection function
- With panic function
- Available in various finishes
- Barrier-free solution
- Multi-functional usability
- Tested and approved technology

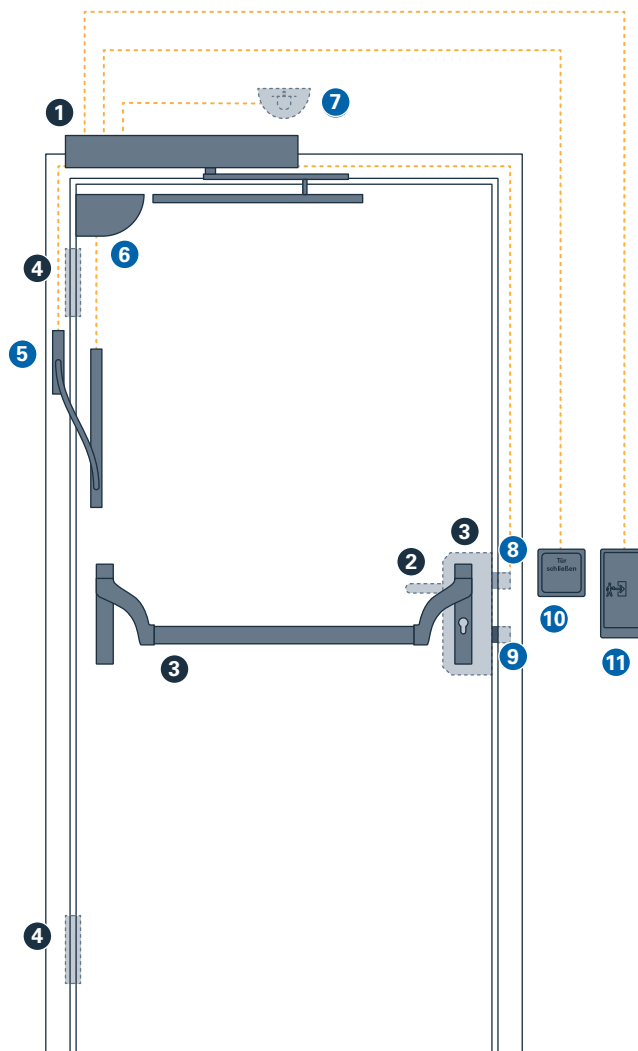

View pull side



① Door closer
ETS 64 R (opens through Push&Go - EPN)



1x

② Fitting
OGL short plate
D-110



1x

③ PSVT
EPN 900 IV + GBS-92



1x 1x

④ Hinge
Horizon OBX-18



2x

⑤ ITM
Cable connection



1x

⑥ ITM
Flatscan



1x

⑦ ITM
Radar



1x

⑧ ITM
E-opener



1x

⑨ ITM
Bolt switch contact



1x

⑩ ITM
HAT 02



1x

⑪ ITM
ECO GFT



1x

<input checked="" type="checkbox"/> PUBLIC	<input checked="" type="checkbox"/> EDUCATION
<input checked="" type="checkbox"/> HEALTHCARE	<input type="checkbox"/> INDUSTRY
<input type="checkbox"/> OFFICE	<input type="checkbox"/> RESIDENTIAL
<input type="checkbox"/> TRANSPORT	<input checked="" type="checkbox"/> HOTEL

NORMS:

EN 16034, EN 1154,
EN 12209, EN 1125,
EN 1935, EN 16005,
DIN 18263-4, DIN 18273

ECO Configurator

Find out more
information here
or get in touch with
us directly:



→ bit.ly/2F65Wnb

#11: DOUBLE-LEAF WOODEN DOOR SET SOLUTION DESIGN

- Mechanical solution
- With fire and smoke protection function
- Available in various finishes
- Tested and approved technology

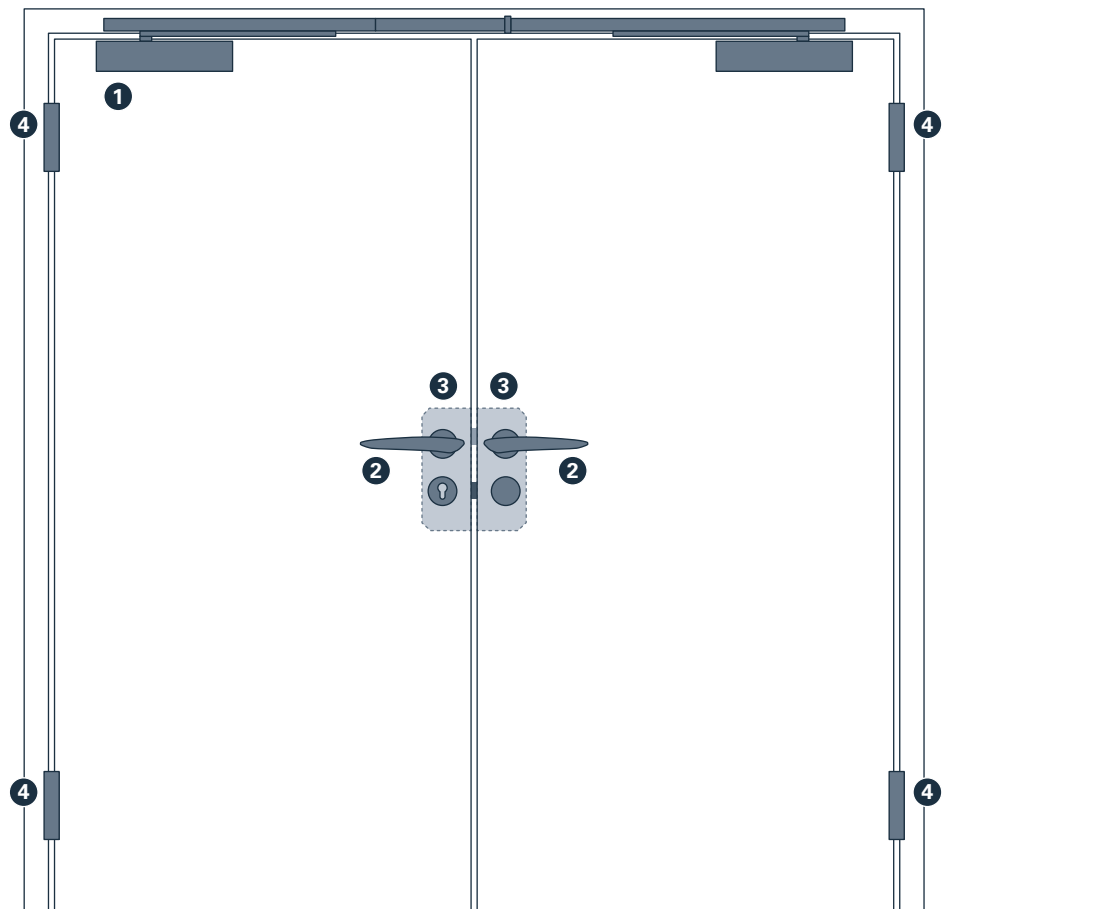

View pull side



① Door closer
TS-41 SR III PVD



1x

② Fitting
Randi Line Wing PVD



4x

③ PSVT
GBS-81 PVD + GBS-94 F PVD



1x

1x

④ Hinge
Horizon OBX-18 PVD

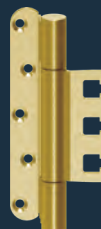

4x

PUBLIC

EDUCATION

HEALTHCARE

INDUSTRY

OFFICE

RESIDENTIAL

TRANSPORT

HOTEL

NORMS:

EN 16034, EN 1154,
EN 1158, EN 12209,
EN 1935, DIN 18040,
DIN 18273

ECO Configurator

Find out more
information here
or get in touch with
us directly:



ECO

→ bit.ly/2CMuoJ2

#12: DOUBLE-LEAF WOODEN DOOR SET SOLUTION ITM

- Mechatronic solution
- With fire and smoke protection function
- With panic function
- Available in various finishes
- Barrier-free solution
- Multi-functional usability
- Tested and approved technology

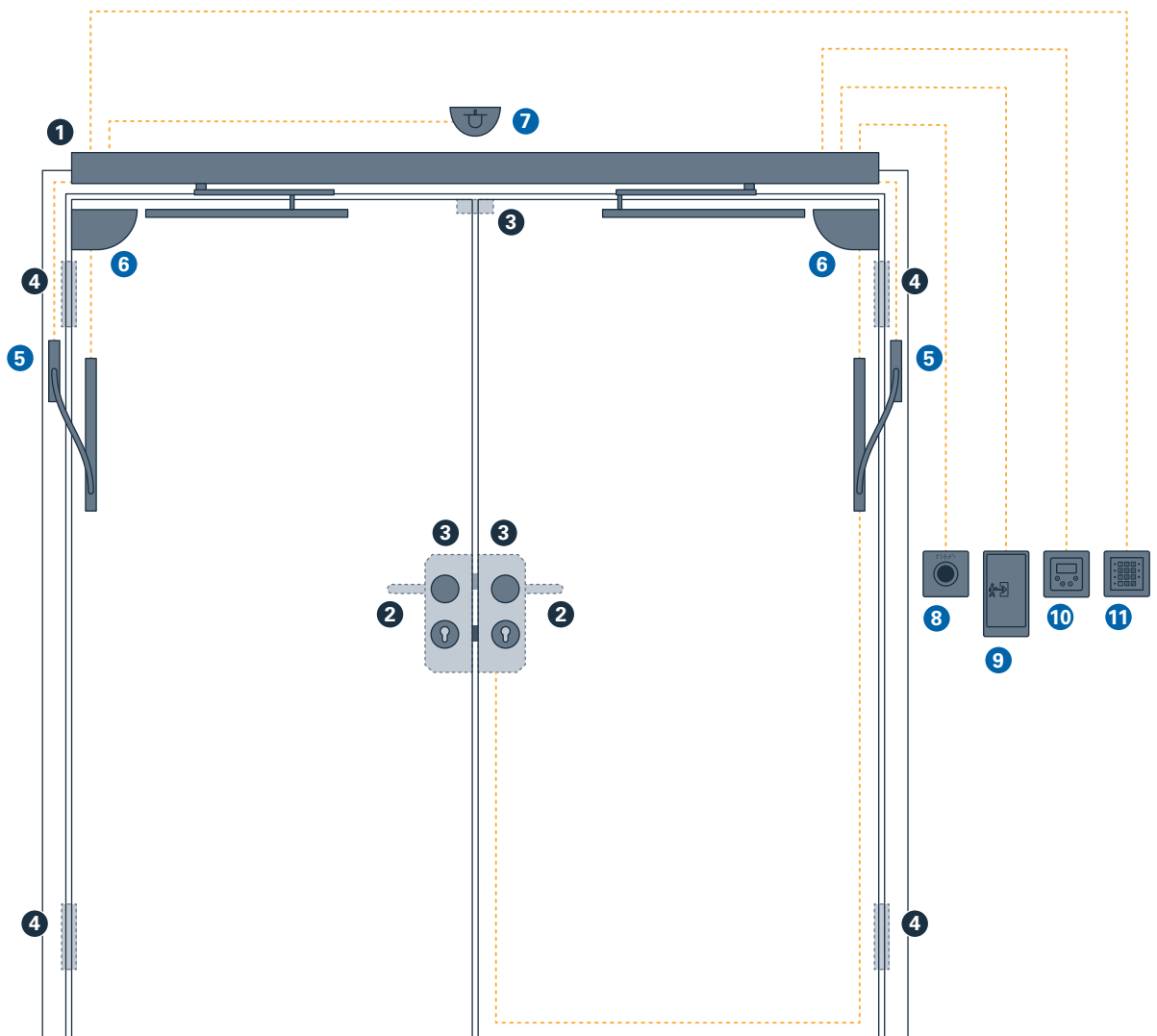

View pull side

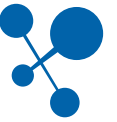

① Door closer
ETS 64-IRM SRI (GSD)



1x

② Fitting
OKL Magis
K-135 / D-330



2x

③ PSVT
GBS 141 + GBS 152 ETÖ + dual locking

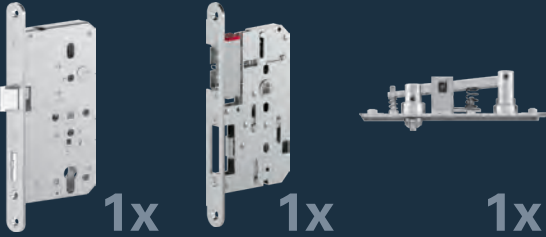

1x 1x 1x

④ Hinge
Horizon OBX-18



4x

⑤ ITM
Cable connection



2x

⑥ ITM
Flatscan



2x

⑦ ITM
Radar



1x

⑧ ITM
BFT



1x

⑨ ITM
ECO GFT



1x

⑩ ITM
Bedix



1x

⑪ ITM
Code batch keyboard
(night mode)



1x

<input checked="" type="checkbox"/> PUBLIC	<input checked="" type="checkbox"/> EDUCATION
<input checked="" type="checkbox"/> HEALTHCARE	<input type="checkbox"/> INDUSTRY
<input type="checkbox"/> OFFICE	<input type="checkbox"/> RESIDENTIAL
<input type="checkbox"/> TRANSPORT	<input checked="" type="checkbox"/> HOTEL

NORMS:

EN 16034, EN 14846,
EN 179, EN 1935,
EN 16005, DIN 18263-4,
DIN 18040, DIN 18273

ECO Configurator

Find out more
information here
or get in touch with
us directly:



→ bit.ly/2QjfOMh

#13: SINGLE-LEAF SECTION DOOR

SET SOLUTION

EXTERNAL DOOR

- Purely mechanical solution
- With panic function and hold-open
- Available in various finishes
- Barrier-free solution
- Tested and approved technology

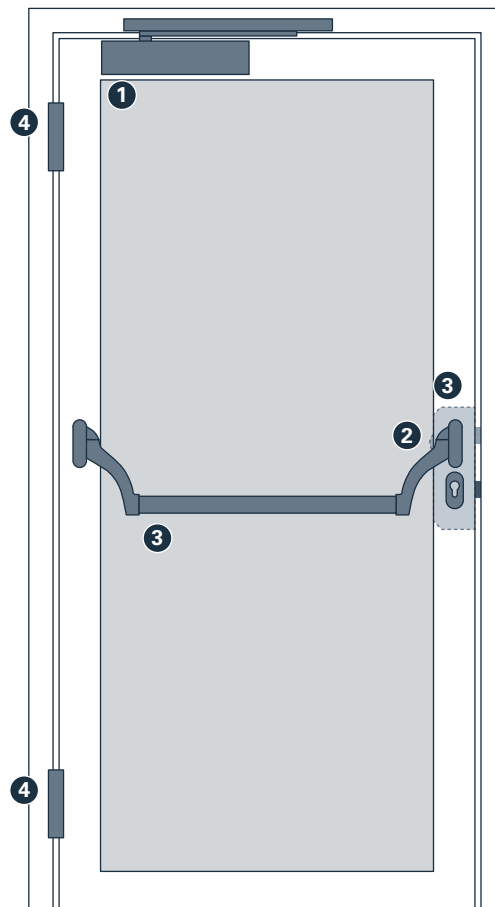

View pull side

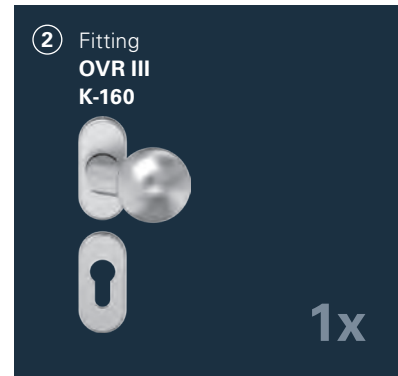
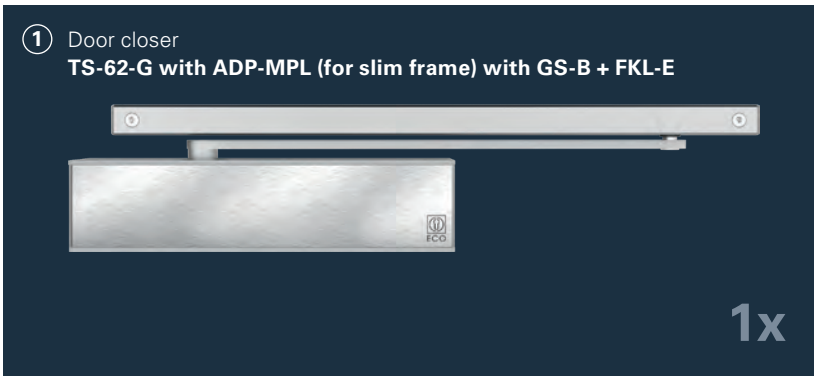

- | | |
|--|---|
| <input checked="" type="checkbox"/> PUBLIC | <input checked="" type="checkbox"/> EDUCATION |
| <input checked="" type="checkbox"/> HEALTHCARE | <input type="checkbox"/> INDUSTRY |
| <input checked="" type="checkbox"/> OFFICE | <input type="checkbox"/> RESIDENTIAL |
| <input checked="" type="checkbox"/> TRANSPORT | <input checked="" type="checkbox"/> HOTEL |

NORMS:

EN 14351-1, EN 1154,
EN 1906, EN 12209,
EN 1125, EN 1935,
DIN 18040,
DIN Spec 1104,
DIN 18273

ECO Configurator

Find out more
information here
or get in touch with
us directly:



→ bit.ly/2Tr1yn0

#14: SINGLE-LEAF SECTION DOOR SET SOLUTION SMOKE AND HEAT EXTRACTION

- Mechatronic solution
- With fire and smoke protection function
- With panic function
- Available in various finishes
- Barrier-free solution
- Multi-functional usability
- Tested and approved technology

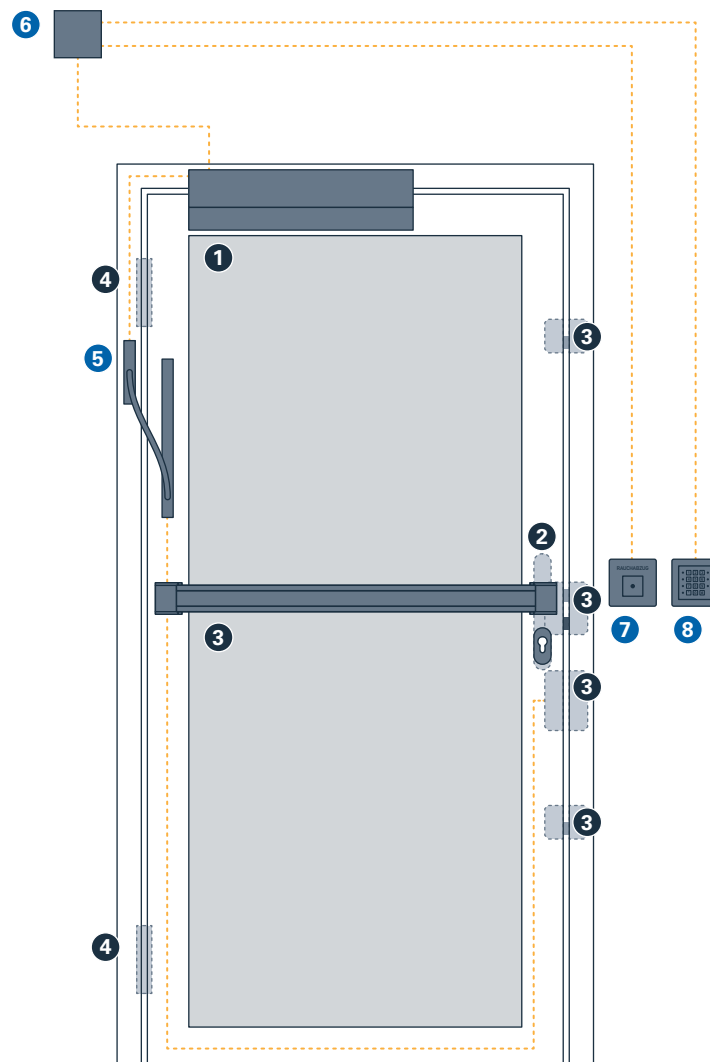

View pull side



① Door closer
FTA ECO Vent (with TS-62)



1x

② Fitting
Protective fitting



1x

③ PSVT
EPN 2000 II + ECO Autotronic 834 PAF B



1x

④ Hinge
OBP-20 roller hinge



2x

⑤ ITM
Cable connection



1x

⑥ ITM
RWA control



1x

⑦ ITM
RWA emergency button



1x

⑧ ITM
Code keypad



1x

<input checked="" type="checkbox"/> PUBLIC	<input checked="" type="checkbox"/> EDUCATION
<input checked="" type="checkbox"/> HEALTHCARE	<input type="checkbox"/> INDUSTRY
<input type="checkbox"/> OFFICE	<input type="checkbox"/> RESIDENTIAL
<input type="checkbox"/> TRANSPORT	<input checked="" type="checkbox"/> HOTEL

NORMS:

EN 12101-2 + EN 14351-1,
EN 14846, EN 1125,
EN 1935, EN 16005,
DIN 18263-4, EN 12101-2,
DIN 18273

ECO Configurator

Find out more information here
or get in touch with us directly:

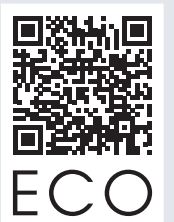

ECO

→ bit.ly/2CMHVQE

#15: SINGLE-LEAF SECTION DOOR SET SOLUTION ITM BARRIER-FREE

- Mechatronic solution
- With fire and smoke protection function
- Available in various finishes
- Barrier-free solution
- Multi-functional usability
- Tested and approved technology
- With escape route terminal

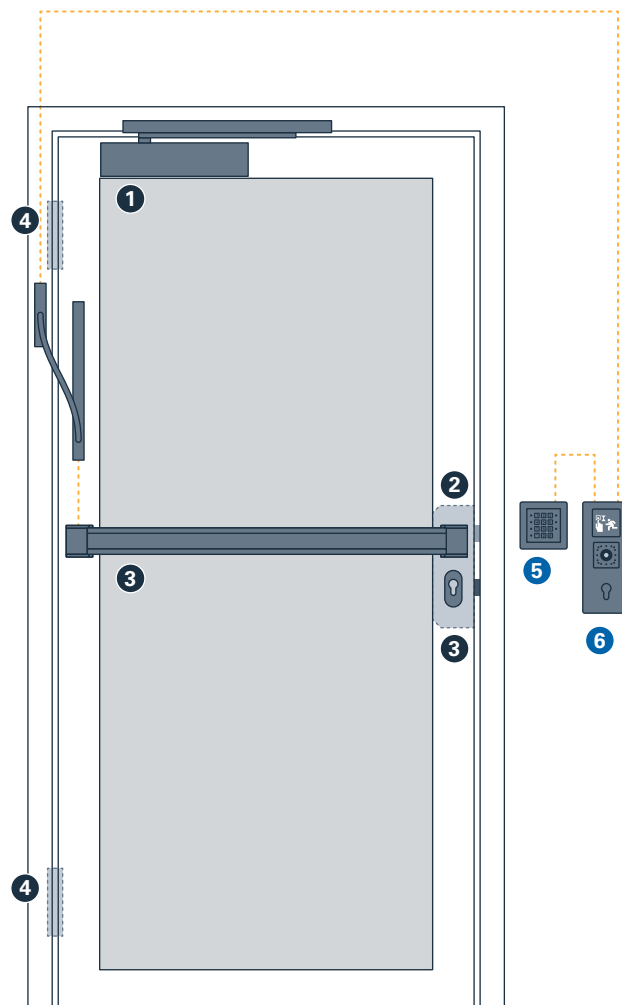

View pull side



① Door closer
TS 62-G with ADP 40



1x

② Fitting
OVR III
D-335

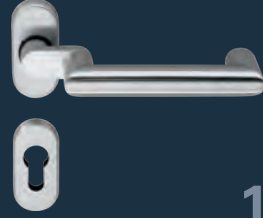

1x

③ PSVT
EPN 2000 III + GBS 96 AVP PAF B



1x

1x

④ Hinge
OBP-20 roller hinge



2x

⑤ ITM
Batch reader



1x

⑥ ITM
FTI terminal



1x

PUBLIC

EDUCATION

HEALTHCARE

INDUSTRY

OFFICE

RESIDENTIAL

TRANSPORT

HOTEL

NORMS:

EN 16034, EN 14846,
EN 179, EN 1158,
EN 1935, EN 16005,
DIN 18263-4, DIN 18040,
EN 14351-1, DIN 18273,
EN 13637

ECO Configurator

Find out more
information here
or get in touch with
us directly:



→ bit.ly/2CMKgLm

#16: DOUBLE-LEAF SECTION DOOR SET SOLUTION FULL PANIC MECHANICAL

- Purely mechanical solution
- With fire and smoke protection function
- With panic function
- Available in various finishes
- Barrier-free solution
- Tested and approved technology

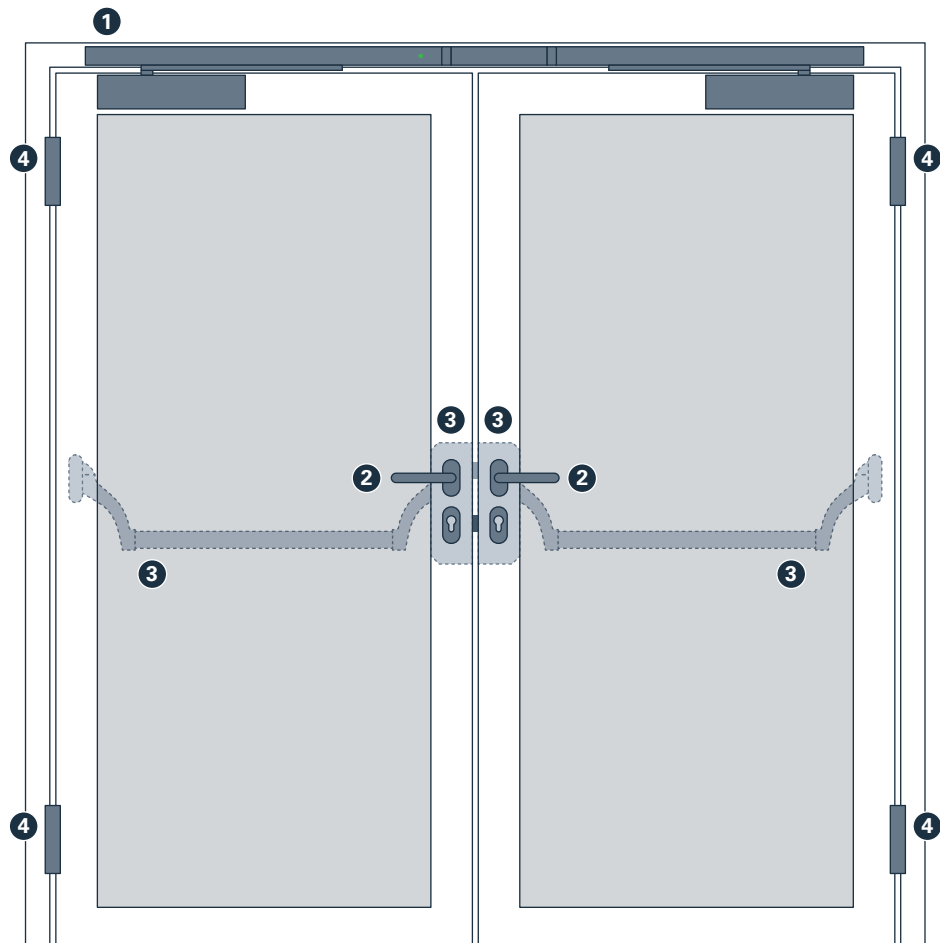

View pull side

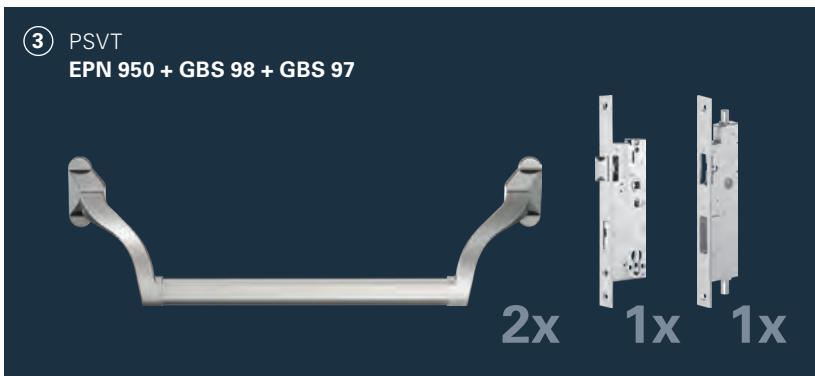
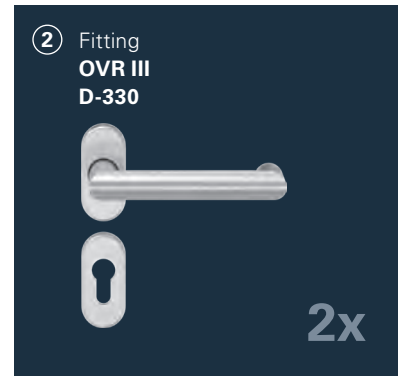
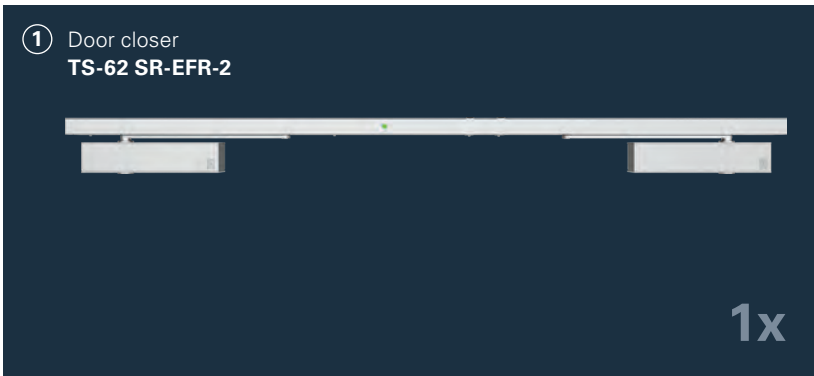

<input checked="" type="checkbox"/> PUBLIC	<input checked="" type="checkbox"/> EDUCATION
<input checked="" type="checkbox"/> HEALTHCARE	<input type="checkbox"/> INDUSTRY
<input type="checkbox"/> OFFICE	<input type="checkbox"/> RESIDENTIAL
<input type="checkbox"/> TRANSPORT	<input checked="" type="checkbox"/> HOTEL

NORMS:

EN 16034, EN 1155,
EN 1158, EN 12209,
EN 1125, EN 1935,
DIN 18040,
DIN SPEC 1104,
DIN 18273

ECO Configurator

Find out more
information here
or get in touch with
us directly:



ECO

→ bit.ly/2VrRtYr

#17: DOUBLE-LEAF SECTION DOOR SET SOLUTION ITM

- Mechatronic solution
- With fire and smoke protection function
- With panic function
- Available in various finishes
- Barrier-free solution
- Multi-functional usability
- Tested and approved technology

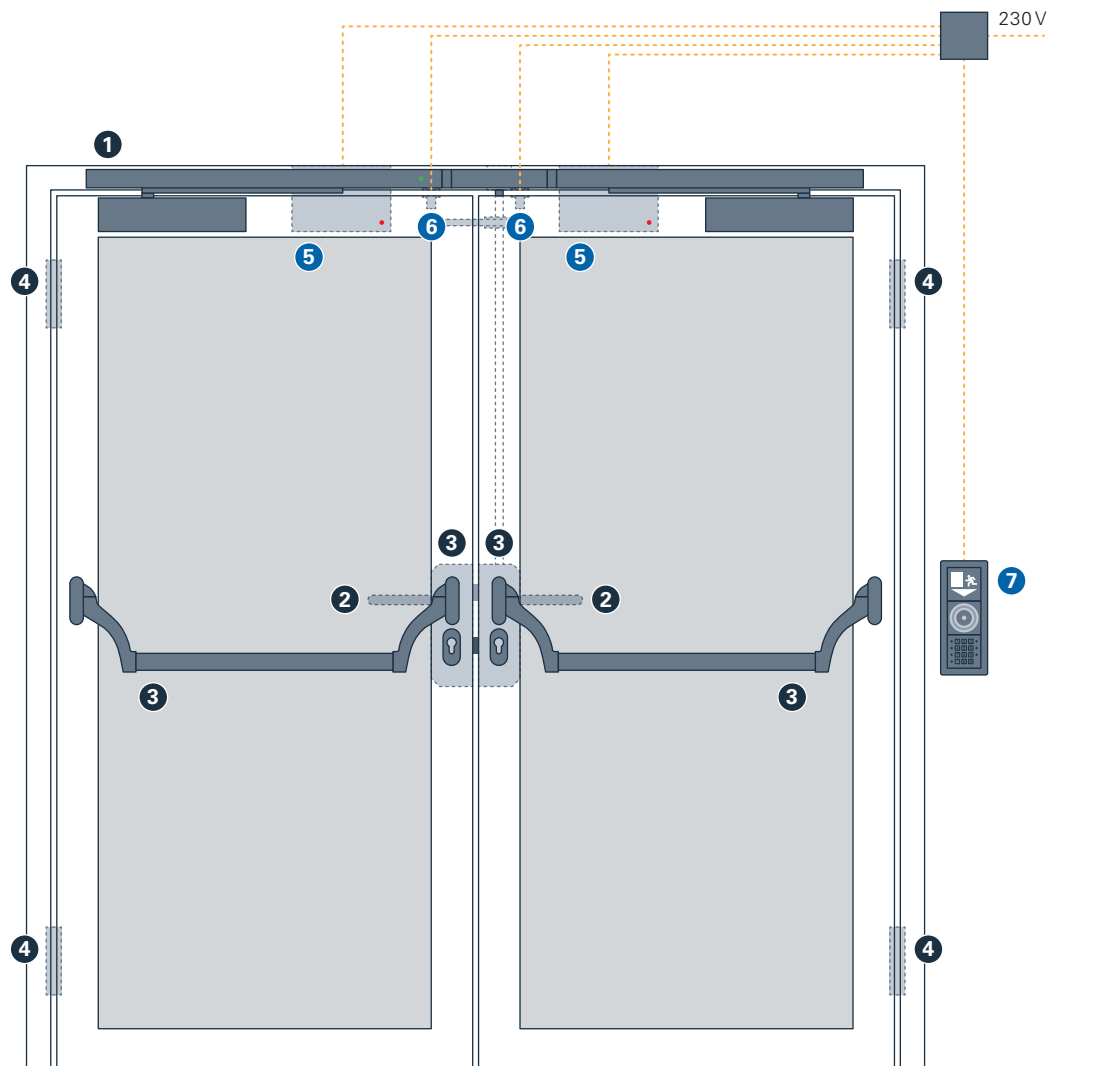

View pull side

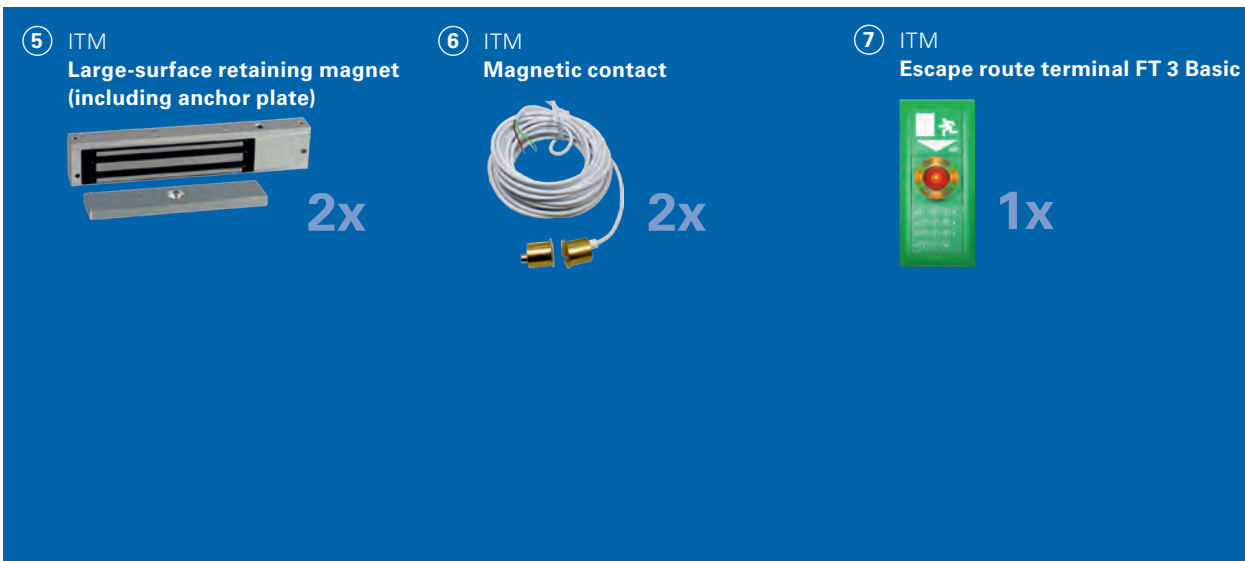
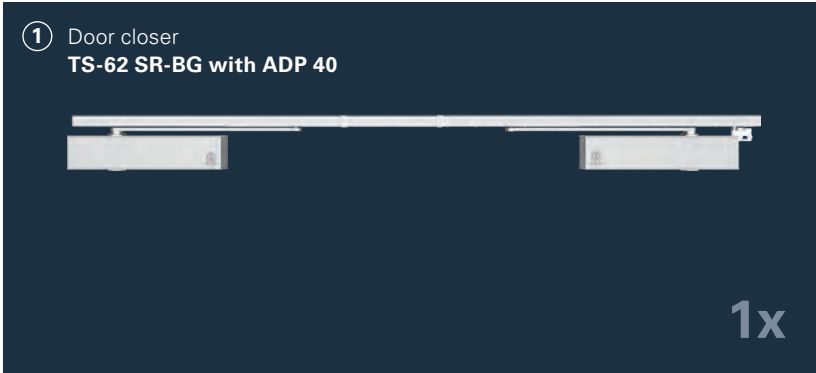

- | | |
|--|---|
| <input checked="" type="checkbox"/> PUBLIC | <input checked="" type="checkbox"/> EDUCATION |
| <input checked="" type="checkbox"/> HEALTHCARE | <input type="checkbox"/> INDUSTRY |
| <input type="checkbox"/> OFFICE | <input type="checkbox"/> RESIDENTIAL |
| <input type="checkbox"/> TRANSPORT | <input checked="" type="checkbox"/> HOTEL |

NORMS:

EN 16034, EN 14846,
EN 179, EN 1158,
EN 1935, EN 16005,
DIN 18263-4, DIN 18040,
EN 14351-1, EN 1125,
EN 13637, EItVTR,
DIN 18273

ECO Configurator

Find out more information here or get in touch with us directly:



→ bit.ly/2s4YOjc



INDIVIDUALLY FOR YOU

ECO DOOR MANAGEMENT

■ SYSTEM TECHNOLOGY FOR THE DOOR



T

Door management



ECO

ECO door management

→ bit.ly/2R57XHB

DOOR MANAGEMENT ECO **FINDER**





With the online “ECO door management” service we accompany and support your planning. A great deal of information on our door technology products can be found by only a few clicks in the ECO Finder. Filters focus your search and make it easier for you to find the products you are looking for. You can also download brochures containing detailed product descriptions and technical data.

Door management

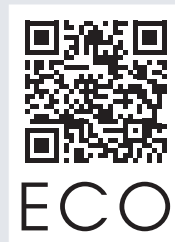

ECO

ECO Finder

→ bit.ly/2LLFJFF

DOOR MANAGEMENT ECO **CONFIGURATOR**





In the ECO configurator, doors can be equipped with ECO products. First you must select the type of door and its characteristics, including weight and width, the number of leaves and the area of application. The products for fitting the door can then be dragged and dropped in place. This also means you can use the planner to check the look, design compatibility and aesthetics at the same time. Furthermore, you can include special emergency and fire protection requirements. An item list then provides information on the selected products. Once configuring has been completed, a request can be sent directly to ECO Schulte. Last but not least, common system solutions can also be selected.

Door management

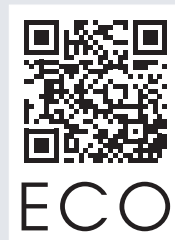

ECO

ECO Configurator

→ bit.ly/2VsVVpV



ALWAYS THERE FOR YOU.
**CONTACT
PERSON**



Your ECO contact
for building projects and sales

📞 +49 (0) 2373 9276 - 0
✉️ objekt@eco-schulte.de

Your ECO contact
for intelligent door management

📞 +49 (0) 2373 9276 - 6099
✉️ itm@eco-schulte.de

Your ECO contact
for service

📞 +49 (0) 2373 9276 - 899
✉️ eco-service@eco-schulte.de

Your Randi contact

📞 +49 (0) 2373 9276 - 7770
✉️ randi@eco-schulte.de

ECO Schulte GmbH & Co. KG

Iserlohner Landstraße 89

D-58706 Menden

Telephone +49 2373 9276 - 0

Telefax +49 2373 9276 - 40

info@eco-schulte.de

www.eco-schulte.de

